



CS5

Conference System

User Manual

Please read before using the equipment!

AKG[®]
by HARMAN

Table of Contents

- Symbols Used..... 5
- Safety and Environment..... 6
- FCC Statement 7
- Section 1: General 8
- Section 2: Notes on Wiring and System Examples 9
 - 2.1 Notes on Wiring and System configuration 9
 - 2.2 System Examples..... 10
 - 2.2.1 Simple discussion system..... 10
 - 2.2.2 Computer- controlled Discussion system 11
 - 2.2.3 Infrared Interpretation System..... 12
 - 2.2.4 Large Conference System with Interpretation Booths..... 14
- Section 3: CS5 BU Base Unit..... 16
 - 3.1 General..... 16
 - 3.2 Front Panel 16
 - 3.3 Rear Panel..... 18
 - 3.4 Setting Up the Base Unit 20
 - 3.4.1 Block Diagram..... 20
 - 3.4.2 Configuring the Dip Switches 21
 - 3.4.3 Selecting NOM Limitation/Interpretation Channels 22
 - 3.4.4 Powering Up..... 22
 - 3.4.5 Setting Levels 24
- Section 4: CS5 DU Delegate Station 25
 - 4.1 Introduction..... 25
 - 4.2 Controls, Inputs, and Outputs 25
 - 4.3 Setting Up 26
 - 4.3.1 Making Connections 26
 - 4.3.2 Selecting Operating Modes 27
- Section 5: CS5 VU Voting/Chairperson Station 29
 - 5.1 Introduction..... 29
 - 5.2 Control Panel, Inputs, and Outputs..... 29
 - 5.3 Setting Up 31

5.3.1 Making Connections	31
5.3.2 Selecting Operating Modes	31
5.3.3 DELEGATE Mode	33
5.3.4 PRESIDENT Mode.....	35
5.4 Voting/Polling	37
5.4.1 Controlling a Ballot or Opinion Poll (PRESIDENT Mode)	37
5.4.2 Voting in DELEGATE Mode.....	39
5.4.3 Voting Feedback.....	41
5.5 Chip Card Identification	42
5.6 Operating modes of the system	44
5.6.1 NORMAL mode	44
5.6.2 FIFO mode	44
5.6.3 REQUEST mode	45
Section 6: CS5 IU Interpreter Station.....	46
6.1 Introduction.....	46
6.2 Control Panel, Inputs, and Outputs.....	46
6.3 Setting Up	48
6.3.1 Making Connections	49
6.3.2 Setting up Interpreter Station.....	49
6.3.3 Example for Selecting Target Language Channels	53
6.3.4 List of Available Language Names	55
6.4 Using the Interpreter Station.....	55
6.5 Instruct the interpreters how to use the Interpreter Stations:.....	56
Section 7: Infrared Transmission System.....	58
7.1 CS5 IRT 1 and CS5 IRT 2 Infrared Radiators.....	58
7.1.1 General	58
7.1.2 Placement.....	59
7.1.3 Mounting	59
7.1.4 Connections	60
7.2 CS5 IRR 7 Infrared Receiver	61
7.2.1 General	61
7.2.2 Using the Infrared Receiver	62

7.2.3 Replacing Batteries	63
7.3 CS5 CU 50 Charger/Storage Case.....	64
7.3.1 General	64
7.3.2 Charging Batteries	65
7.3.3 Battery Care	65
Section 8: System Components.....	66
Section 9: Specifications	67
9.1 CS5 BU	67
9.1.1 General	67
9.1.2 Connector Pin outs.....	68
9.2 CS5 DU/VU.....	70
9.2.1 General	70
9.2.2 Connector Pin outs.....	70
9.3 CS5 IU.....	71
9.3.1 General	71
9.3.2 Connector Pin outs.....	71
9.4 CS5 PS 12	72
9.5 CS5 IRT 1 and CS5 IRT 2.....	73
9.6 CS5 IRR 7.....	73
9.7 CS5 CU 50.....	74
9.8 Conformity.....	74

Symbols Used



The lightning flash with arrow point in the circle means that, there are dangerous voltages present within the equipment.



The exclamation point indicates that it is necessary for the user to refer to the User Manual or Quick start Guide. This symbol marks instructions that the user must follow to ensure safe operation of the equipment.



The  symbol marks important notes, hints, or explanations that make it easier to use the equipment.

Safety and Environment

Safety Instructions

- 1) Do not spill any liquids on the equipment and do not drop any objects through the ventilation slots in the equipment.
- 2) Use the equipment in dry rooms only. Do not expose the equipment to rain or splash water. Never place objects containing liquids (e.g., vases) on or near the equipment.
- 3) There are no user-serviceable parts inside the equipment. Do not attempt to service the equipment yourself. Refer all servicing to qualified personnel. Opening the chassis for any reason will void the manufacturer's warranty.
- 4) Before connecting the equipment to power, check that the AC mains voltage stated on the power supply included with the equipment is identical to the AC mains voltage available where you will use the equipment. Also check that the power outlet is a standard type with a protective ground connection. Disconnecting the protective ground lead or using non-standard power plugs or non-standard power outlets is illegal.
- 5) Operate the equipment with the power supply included with the equipment only. Using a different power supply may cause serious damage to the unit.
- 6) If any solid object or liquid penetrates into the equipment, shut down the system immediately. Disconnect the equipment from power immediately and have the equipment checked by AKG service personnel.
- 7) If you will not use the equipment for a long period of time, disconnect the equipment from power. Please note that the equipment will not be fully isolated from power when you set the power switch to OFF.
- 8) Disconnect the equipment from power during storms to prevent damage.
- 9) Make sure to route power supply cords so that they are not likely to be walked on or pinched by items placed upon or against them, paying particular attention to cords at plugs, convenience receptacles, and the points where they exit from the equipment.
- 10) To avoid hum or interference, route all audio lines, particularly those connected to microphone inputs, away from power lines of any type. If you use cable ducts, be sure to use separate ducts for the audio lines.

Safety and Environment

- 11) Make sure to replace each built-in fuse with a standard fuse of the same type and rating only. Using any other type of fuse may cause excessive heating and/or a risk of fire.
- 12) Never switch more than twenty microphone stations on simultaneously because the resulting current drain may cause a risk of fire.
- 13) Do not place the equipment near heat sources such as radiators, heating ducts, or amplifiers, etc. and do not expose it to direct sunlight, excessive dust, moisture, rain, mechanical vibrations, or shock.
- 14) Clean the equipment with a moistened (not wet) cloth only. Be sure to disconnect the equipment from power before cleaning the equipment! Never use caustic or scouring cleaners or cleaning agents containing alcohol or solvents since these may damage the enamel and plastic parts.
- 15) Use the equipment for the applications described in this manual only. AKG cannot accept any liability for damage resulting from improper handling or misuse.
- 16) Any changes or modifications to the equipment not expressly approved by the manufacturer may void the user's authority to operate the equipment.

Environment

- 1) When scrapping the equipment, separate the case, circuit boards, and cables, and dispose of all components in accordance with local waste disposal rules.
- 2) The packaging of the equipment is recyclable. Dispose of the packaging in an appropriate container provided by the local waste collection/recycling entity and observe all local legislation relating to waste disposal and recycling.

FCC Statement

This device complies with Part 15 of the FCC Rules. Operation is subject to the following two conditions: (1) this device may not cause harmful interference, and (2) this device must accept any interference received, including interference that may cause undesired operation.

Section 1: General

The CS5 is a fully modular, highly flexible conference system. Using Ethernet technology, it provides maximum security and excellent digital audio quality. The CS5 components can be used for any conference system from simple setup's to the most complex systems including ID card identification; three-way voting or five-way polling; interpretation of up to 63 languages; and infrared transmission of up to seven languages. The CS5 is extremely easy to wire, program, set up, and expand.

All microphone stations are connected to the CS5 BU Base Station in a closed-circuit Ethernet configuration so even if one component fails, all other microphone stations will remain functional. The Base Unit also provides all the circuitry required to drive the CS5 IRT1 and CS5 IRT2 infrared radiators. The CS5 IRR7 infrared receivers provide seven selectable language channels. In addition, the CS5 BU contains interfaces for a range of external devices including mixers, wireless microphone systems, recording devices, CD players, etc.

The system provides 64 audio channels (0 - 63) that can be assigned as required to delegate, chairperson, or interpreter stations. Channel 0 is permanently assigned as the floor channel (sum of all microphone stations, external microphones (unless routed otherwise) and line inputs). Channels 0-6 are routed to the infrared outputs. Channels 0-3 are available at the headphone outputs on the CS5 DU microphone station. Channels 0-63 are available at the headphone outputs on the CS5 VU microphone station.



Important:

- To avoid malfunctioning due to conflicting signals, use only a single CS5 BU Base Unit in any CS5 conference system.
- To avoid data loss or corruption, malfunctioning, or damage to the system, never make any changes to the wiring or operate any control on any system component, or disconnect the system from power while a software update is in progress.
- To make the system work properly, kindly use the cables provided by AKG if you use your own CAT5 cables take care that they are properly SHIELDED



Note:

- For instructions on setting up your CS5 Conference System from wiring to powering up, refer to the "Getting started quickly" guide that you should have received together with your shipment. If the "Getting started quickly" guide or any other component is missing, contact your AKG Distributor immediately.
- This User Manual contains detailed information on how to set up each CS5 component. While a software update is in progress.

Section 2: Notes on Wiring and System Examples

2.1 Notes on Wiring and System configuration



Important:

1. Never connect your CS5 MK... LAN cables to any equipment (desktop or notebook computers, etc.) other than CS5 system components. The LAN cables will carry a 48 V supply voltage that may damage equipment not designed for such voltages.
2. Make all audio and LAN cable connections before connecting any Conference System component to power.
3. To avoid damage to any system component, do not lay, connect, or disconnect any cables while power to the system is on. Always disconnect the entire system from power before making any changes to the wiring.
4. To avoid interference problems, make sure that all audio cables you are going to connect to the Base Unit audio outputs are shorter than 10 feet (3 m).
5. Note that the CS5 BU Base Unit will not function with no microphone stations connected to it (no matter what other equipment you may have connected to the Base Unit). Therefore, make sure always to connect at least one CS5 VU or CS5 DU microphone station to the Base Unit to set up a functional CS5 system.

- Route power cables so that nobody may trip over them or step on them. A cable getting disconnected by somebody tripping over it may cause system malfunctioning or damage to system components.
- To avoid hum problems, do not route audio or LAN cables close to power cables. In permanent installations, use separate ducts for power and audio/LAN cables.
- While LAN cables may be as long as 164 feet (50 m) without degrading system performance, keep all other cables as short as possible to keep cable attenuation to a practical minimum. Check that all audio cables connected to the Base Unit are shorter than 10 feet (3 m).
- Always connect all microphone stations in any system to the Base Unit in a closed loop. Use CS5 MK... LAN cables to daisy-chain all microphone stations from one SYSTEM connector on the Base Unit back to the other SYSTEM connector on the Base Unit. This ensures that if one of the LAN cables breaks, all other microphone stations will remain operative.

Section 2: Notes on Wiring and System Examples

2.2 System Examples

2.2.1 Simple discussion system

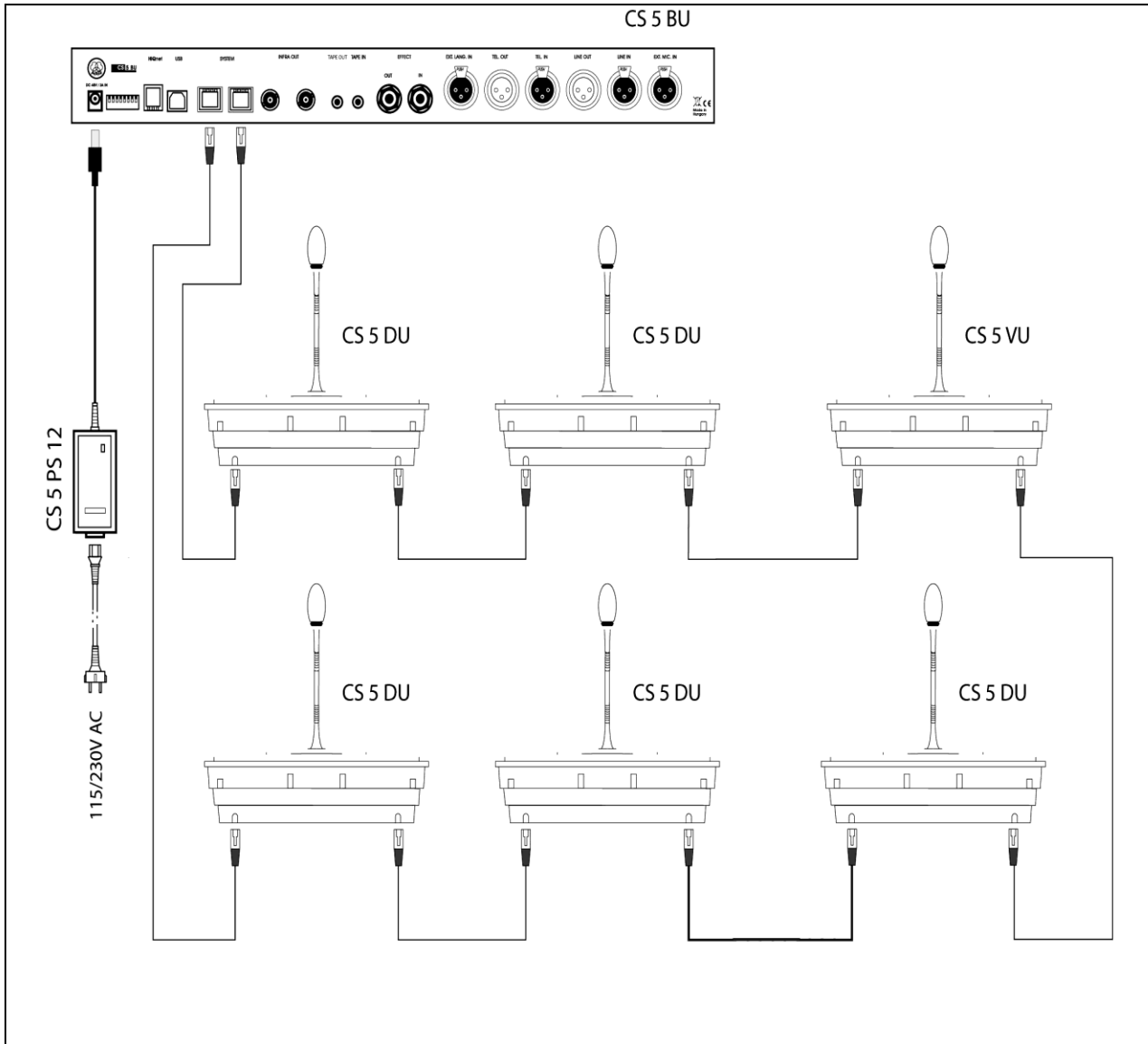

Example 1: Simple discussion system.

Example 1 above shows the wiring diagram for a simple discussion system. A system of this kind may comprise any combination of CS5 DU and CS5 VU microphone stations. Since the system shown includes only six microphone stations, a single CS5 PS 12 power supply connected to the Base Unit is enough to power the entire system.

Section 2: Notes on Wiring and System Examples

2.2.2 Computer- controlled Discussion system

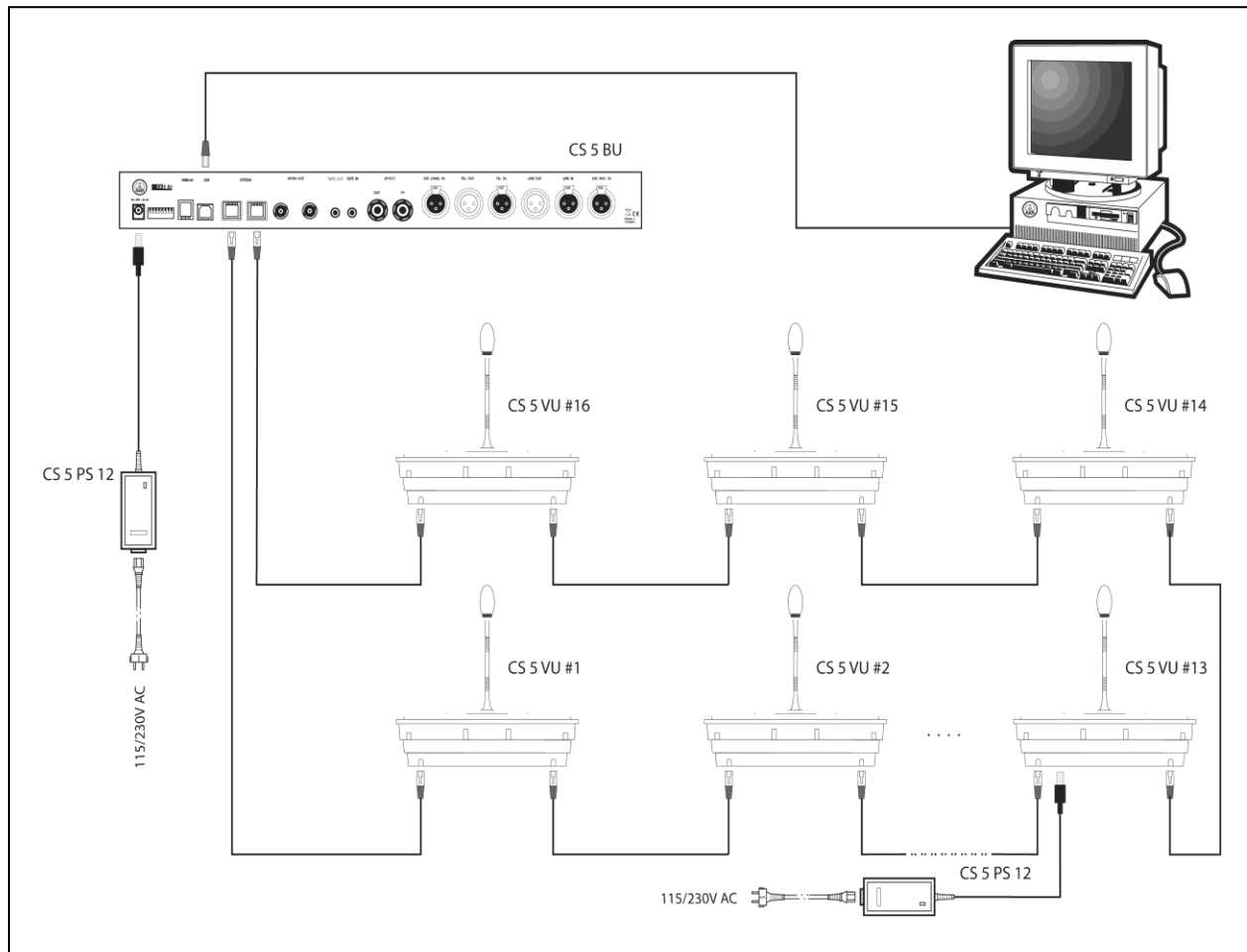

Example 2: Larger discussion system with computer control.

Example 2 above shows a larger discussion system with more than six microphone stations and computer control. To ensure stable powering even if one power supply fails, connect one CS5 PS 12 power supply to the Base Unit, one CS5 PS 12 power supply to every sixth microphone station, beginning with the seventh in line counting from the Base Unit, and connect the last microphone station to the second SYSTEM connector on the Base Unit.

The computer controlling the system is connected to the USB port on the Base Unit. In order to make optimum use of all the functions offered by computer control, we recommend using CS5 VU microphone stations, although computer control will also work with CS5 DU stations.

Section 2: Notes on Wiring and System Examples

2.2.3 Infrared Interpretation System

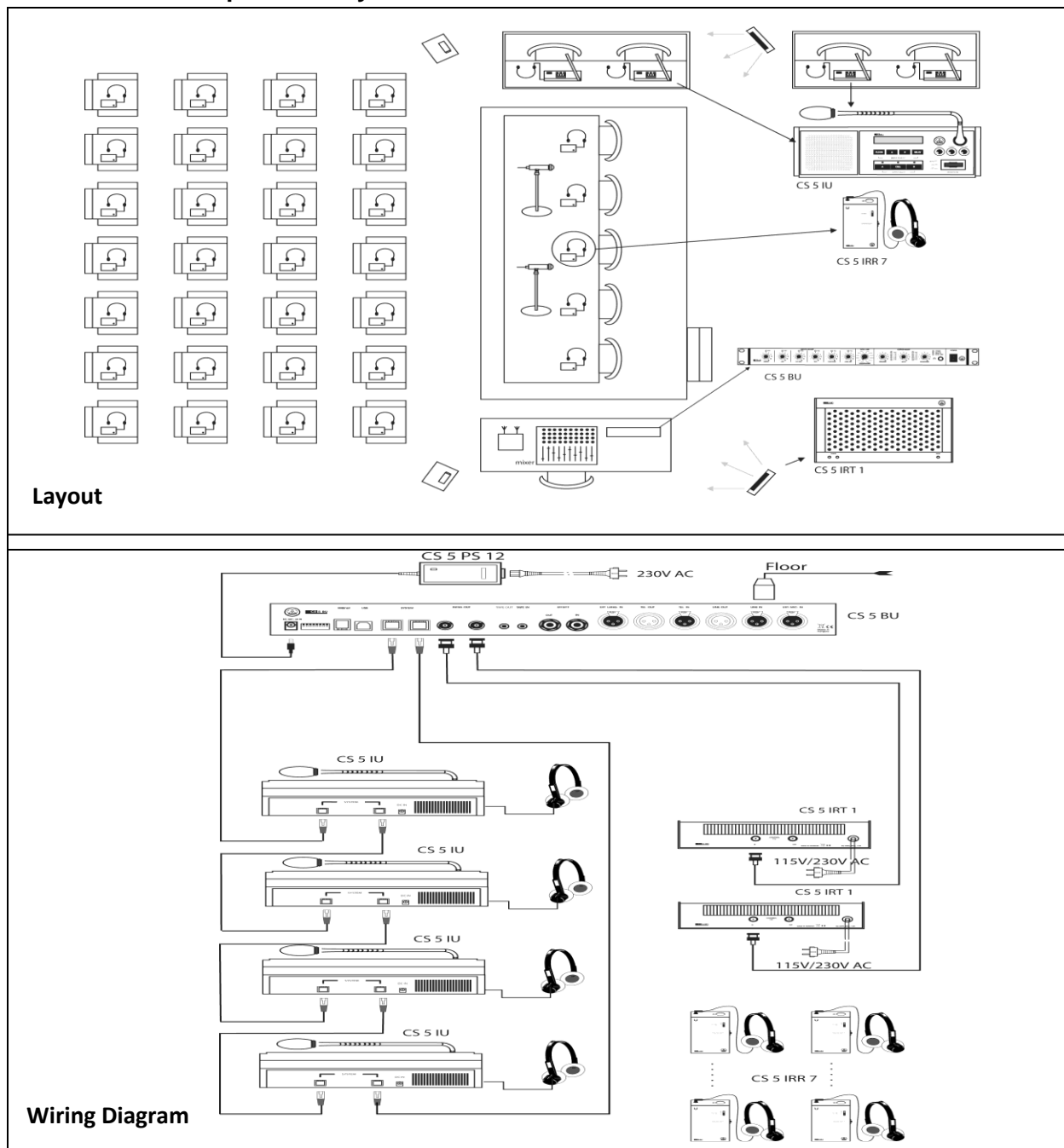

Example 3: Basic layout and wiring diagram for an interpretation system for three conference languages with infrared signal distribution.

The panel microphones (2 shown in the layout diagram above) are connected to a microphone mixer, which feeds the LINE IN input on the Base Unit. The room sound system is fed by the Base Unit LINE OUT output. The four Interpreter Stations in the

Section 2: Notes on Wiring and System Examples

two interpretation booths are connected in a closed loop to the two SYSTEM connectors on the Base Unit.

Section 2: Notes on Wiring and System Examples

2.2.4 Large Conference System with Interpretation Booths

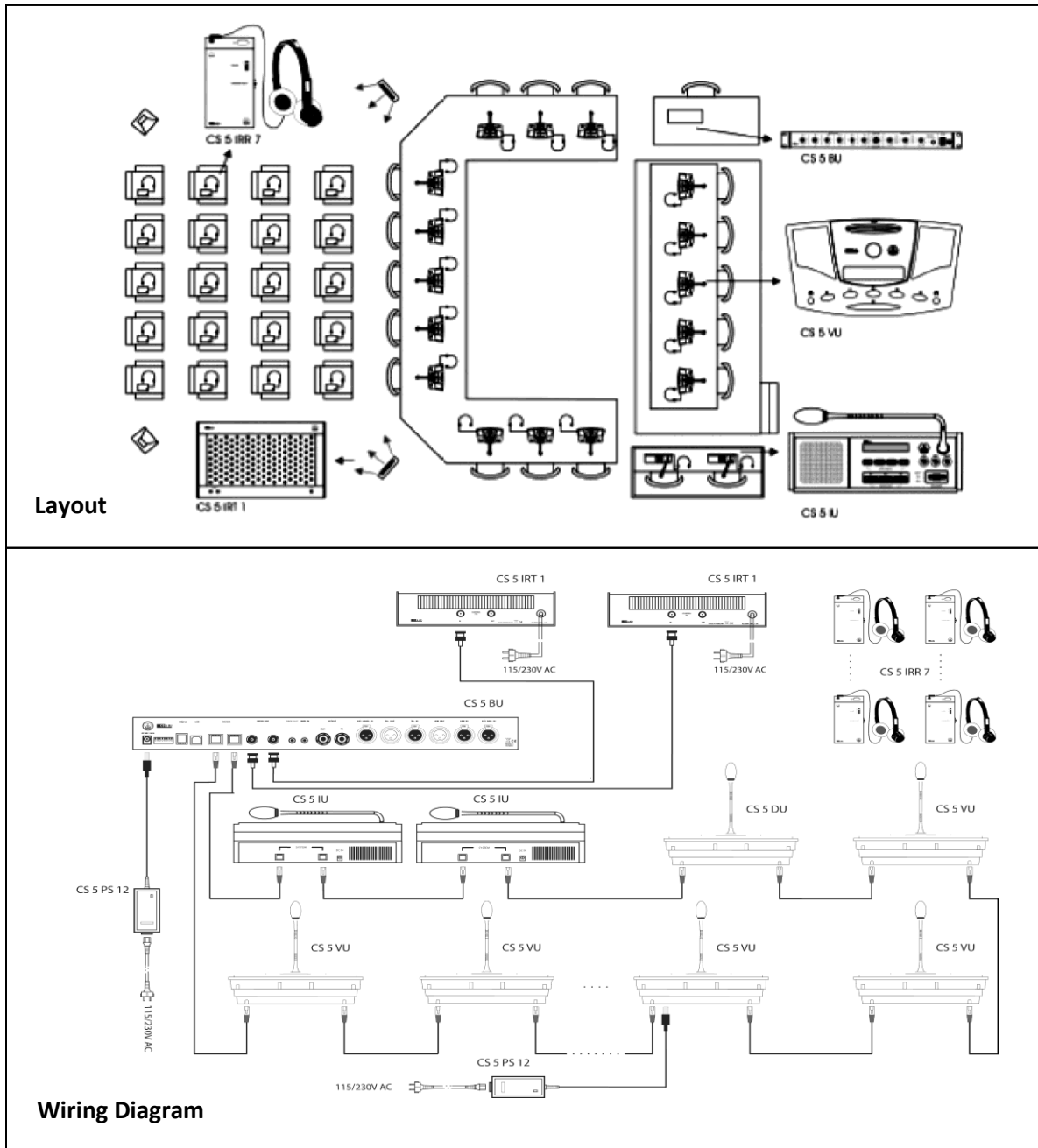

Example 4: Large conference system layout and wiring diagram.

Example 4 shows a large conference system with CS5 VU microphone stations with voting and polling functions, an interpretation booth for one target language, and an infrared distribution system for the audience. The chairperson, panelists, and delegates

Section 2: Notes on Wiring and System Examples

can listen to the loudspeakers on the Delegate Stations or use the headphones to listen to the interpreters. Since all microphones are connected to CS5 microphone stations, no external microphone mixer is needed. The audience can listen to the floor signal or interpretation on their CS5 IRR 7 infrared receivers with channel selectors. The wiring diagram shows how all microphone stations including the Interpreter Stations are daisy-chained together in a closed loop.

To ensure stable powering, even if one power supply fails, connect one CS5 PS 12 power supply to the Base Unit, one CS5 PS 12 power supply to every sixth microphone station, beginning with the seventh in line counting from the Base Unit, and connect the last microphone station to the second SYSTEM connector on the Base Unit.

Section 3: CS5 BU Base Unit

3.1 General

The CS5 BU is the Base Unit required for any CS5 system configuration. It synchronizes all system components and generates the floor audio channel. You can connect to the Base Unit up to 5,000 microphone stations (Delegate Stations, Chairperson Stations, and Interpreter Stations); external analog audio sources; an external amplifier; an audio recording device; and one or more infrared radiators.

The CS5 BU provides the following basic control functions:

- **NOM limit:** Maximum number of microphones that may be open at any time, selectable from 1 to 63.
- Two selectable automatic microphone activation modes. (Through Dip switches)
- One more selectable microphone activation mode from the president/chairman unit.
- Driving the infrared radiator panels.

More control functions are available through computer control using the CS5 Confer Control software.

3.2 Front Panel

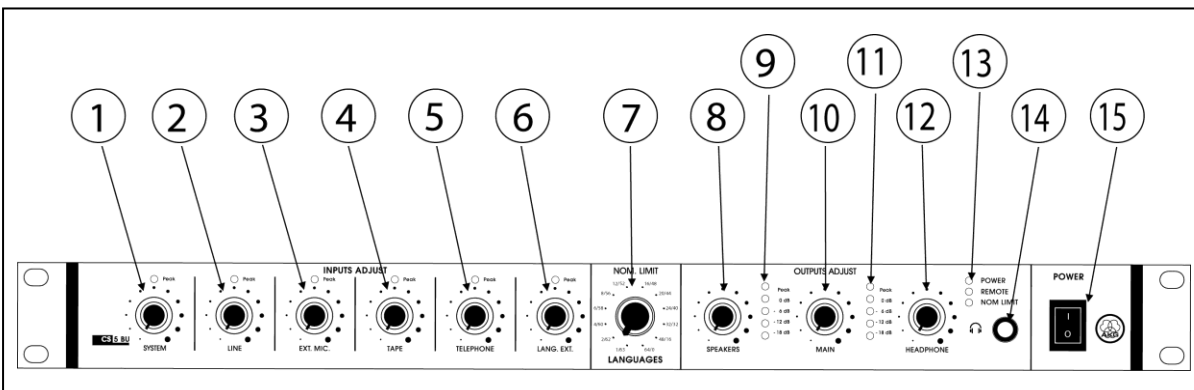

Fig. 1: CS5 BU front panel.

- 1 **SYSTEM:** Sets the level of the sum of all open microphones on the microphone stations.
- 2 **LINE:** Sets the level of the rear panel LINE IN line level input.
- 3 **EXT. MIC:** Sets the level of the rear panel EXT. MIC IN microphone level input.
- 4 **TAPE:** Sets the level of the rear panel TAPE IN input for an external audio source.
- 5 **TELEPHONE:** Sets the level of the rear panel TEL. IN input for an external telephone hybrid.

Section 3: CS5 BU Base Unit

- 6 **LANG. EXT.:** Sets the level of the rear panel EXT. LANG. IN input for an external hardwires or wireless microphone used by an interpreter working outside the interpretation booths.
- 7 **NOM LIMIT:** Sets the maximum number of microphones (NOM) that may be open simultaneously at any time and the number of audio channels available for interpretation. "1/62" means one open microphone and 62 interpretation channels, "63/0" means 63 open microphones and no interpretation channel^{1 2}.
- 8 **SPEAKERS:** Sets the level of the signal fed to the loudspeakers on the microphone stations.
- 9 **LED level meter** indicating the level set by the SPEAKERS control (8). Set the SPEAKERS control (8) so that the red Peak LED will only flash occasionally at very loud signals.
- 10 **MAIN:** Sets the level of the rear panel LINE OUT line-level output.
- 11 **LED level meter** indicating the level set by the MAIN control (9). Set the MAIN control (9) so that the red Peak LED will only flash occasionally at very loud signals.
- 12 **HEADPHONE:** Sets the level of the headphone output (14) to the right of the HEADPHONE control.
- 13 **Status LEDs:** The CS5 BU indicates different states of the system through the status LEDs which are available on the front panel of the unit:
 - POWER** (green) is lit to indicate that power to the Base Unit is ON.
 - REMOTE** (yellow) flashes to indicate that data is being transmitted and the system is controlled by the PC software.
 - NOM LIMIT** (yellow) flashes to indicate a synchronization error or when the NOM limit is reached to its maximum as set.
 - POWER UP:** The REMOTE LED will be flashing for a few seconds to indicate the system is synchronizing and go out as soon as synchronization is completed. Once the REMOTE LED stops flashing after few seconds, NOM LIMIT LED will be blinking continuously indicating that the Abbreviation list is getting downloaded and will be off as soon as synchronization is completed.
 - LEARNING:** While learning the system, the Line level LED's will be running up and down indicating that the system is getting learned.
 - AUTO LEARN**³: NOM LIMIT LED & REMOTE LED will be blinking alternatively, indicating that a learn process is required for the system.

¹ NOM LIMIT setting is ONLY applicable to non priority stations. NON Priority stations consist of President Station or delegate stations whose priority mode is switched ON through the Dip switch of that particular station.

² NOM LIMIT can also be set remotely through CS5 confer control software, which will be overriding the NOM LIMIT set over BU. If the NOM limit is set to ZERO remotely then, the value which is set over BU will be getting evaluated for allocating the MIC. This feature will be available from V3 of the confer control software.

³ Auto learn will be happening in 3 conditions, which are mentioned below.

- During Start-up of the system.
- Whenever Abbreviation list is downloaded and there is a request from any of the device to BU indicating a learn process is required.
- Whenever a new device is added to the existing ring

Section 3: CS5 BU Base Unit

- 14  ¼" TRS headphone jack for stereo headphones only. (Using mono headphones may damage the unit.)
- 15 **POWER**: Switches power to the Base Unit ON ("I") or OFF ("O").

3.3 Rear Panel

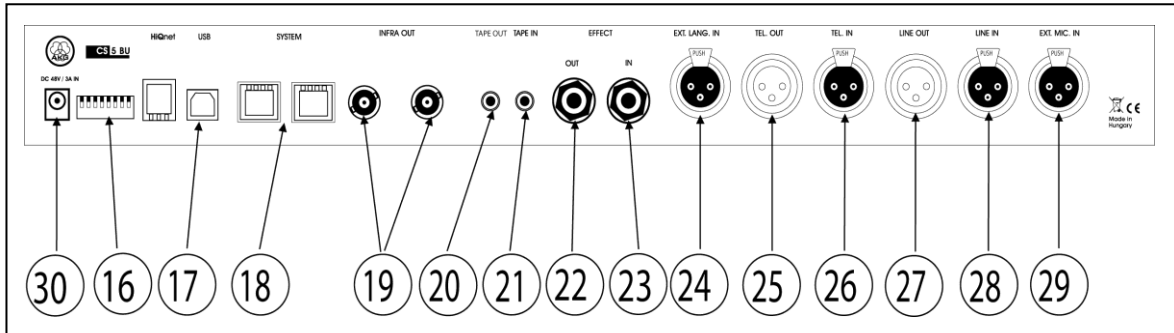

- 16 **Dip switches**: This set of dip switches allows you to route the various inputs to either the NORMAL bus or the EFFECTS bus, activate or deactivate NOM limitation on the SYSTEM BUS and LINE OUT outputs, mute the EXT. LANG. Signal. Refer to section 3.4.
- 17 **USB port**: Enables the Base Unit to be controlled from a computer. Computer control works best with CS5 VU advanced delegate stations. The CS5 DU may not provide all the functions that may be required for more complex systems.
- 18 **SYSTEM**: These two RJ 45 connectors provide the inputs, outputs, and power voltage for the microphone stations connected to the Base Unit. Daisy-chain the microphone stations and connects the last station in the chain to the second SYSTEM connector on the Base Unit. This makes sure that if one microphone station fails, all other stations will remain fully functional.
- 19 **INFRA OUT**: These two coaxial connectors carry the same signal for the CS5 IRT1 or CS5 IRT2 infrared radiators. This signal includes the output signals from the interpretation booths (channels 1-6) and the NORMAL bus signal (channel 0).
- 20 **TAPE OUT**: Unbalanced TRS mini jack carrying the NORMAL bus mono signal for recording.
- 21 **TAPE IN**: Unbalanced TRS mini jack for connecting the output of an external recording device. The input signal is fed to the DIRECT/TELEPHONE bus and can be routed to the NORMAL or EFFECTS buses, too.
- 22 **EFFECT OUT**: Balanced TRS ¼" jack for sending the EFFECTS bus signal to an external effects device, e.g. a feedback eliminator.
- 23 **EFFECT IN**: Balanced TRS ¼" jack for receiving the output signal of an external effects device. This signal is fed to the NORMAL bus.
- 24 **EXT. LANG. IN**: Balanced XLR line-level input for an external microphone mixer or AKG wireless microphone receiver providing an additional interpretation channel. The input signal can be muted or fed to language channel 1 which is part of the infrared signal.

Section 3: CS5 BU Base Unit

- 25 **TEL. OUT:** Balanced XLR connector carrying the output signal of the DIRECT/TELEPHONE bus.
- 26 **TEL. IN:** Balanced XLR input for the output signal of a telephone hybrid. The signal is fed to the NORMAL bus.
- 27 **LINE OUT:** Balanced XLR connector carrying the NORMAL bus signal for the conference room sound system.
- 28 **LINE IN:** Balanced XLR input for a line-level audio source such as a CD player or A/V equipment.
- 29 **EXT. MIC. IN:** Balanced XLR microphone-level input with 48-V phantom power for an external hardwire or wireless microphone.
- 30 **DC 48V / 3A IN:** DC input for connecting the CS5 PS 12 power supply.

Section 3: CS5 BU Base Unit

3.4 Setting Up the Base Unit



Important:

- To avoid interference problems, make sure that all audio cables you are going to connect to the Base Unit audio outputs are shorter than 10 feet (3 m).

3.4.1 Block Diagram

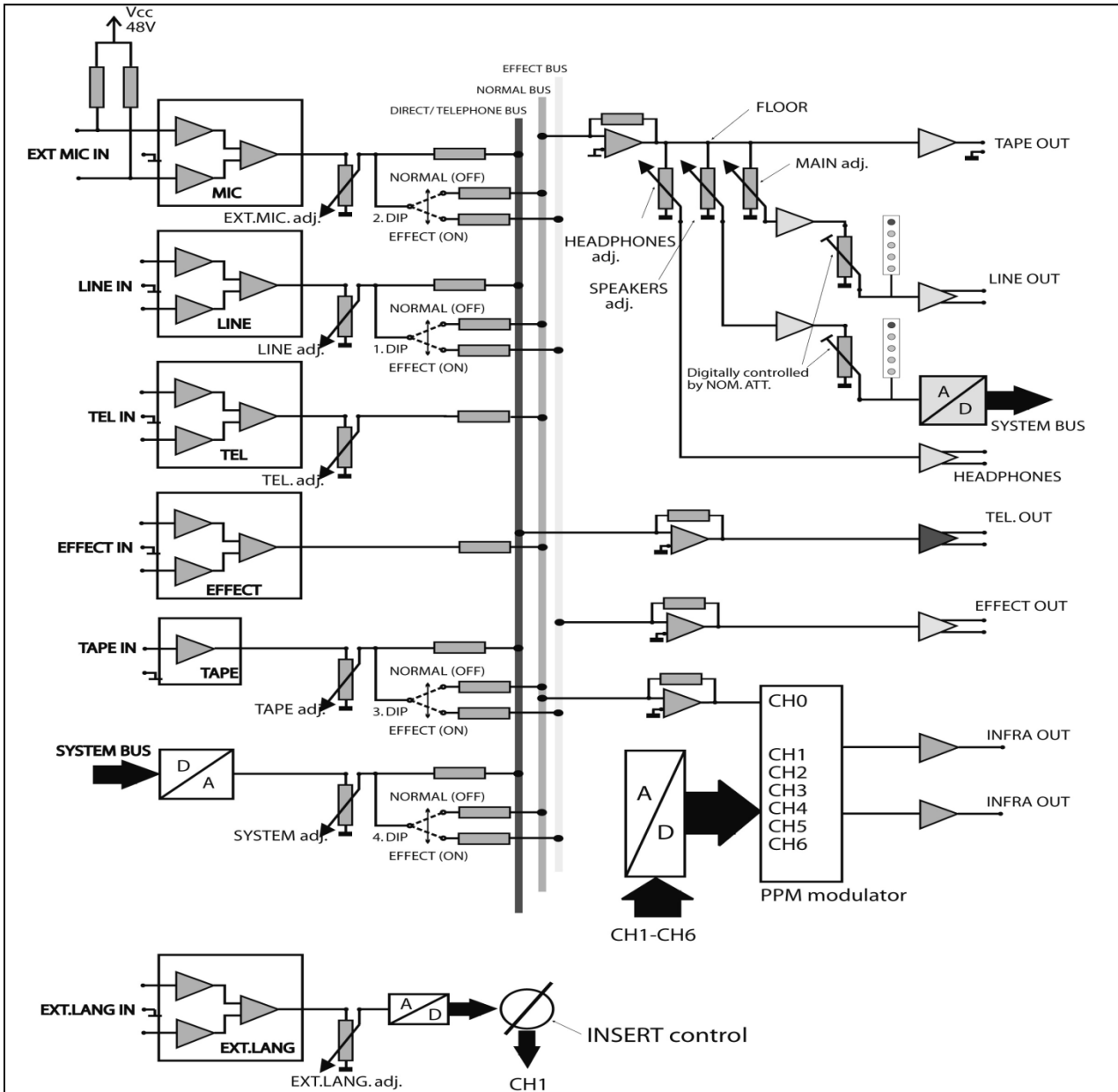

Fig. 3: Block diagram of the CS5 BU analog section.

Section 3: CS5 BU Base Unit

3.4.2 Configuring the Dip Switches

1. Before powering up, set all front panel level controls to minimum (smallest dot) and set the rear panel dip switches as required. Refer to fig. 3 on page 19 and Table 1 below.

Dip switch	Function	Switch position	
		0	1
S1	routes LINE IN	NORMAL	EFFECTS bus
S2	routes EXT. MIC. IN to	NORMAL	EFFECTS bus
S3	routes TAPE IN	NORMAL	EFFECTS bus
S4	routes SYSTEM BUS IN to	NORMAL	EFFECTS bus
S5	switches NOM attenuation on SYSTEM BUS	OFF	ON
S6	switches NOM attenuation on LINE OUT	OFF	ON
S7	EXT. LANG.	muted	routed to Channel 1
S8	Microphone activation mode	Floor request opens available mic channel or puts microphone on waiting list.	FIFO: Floor request opens available mic channel or cancels earliest floor request.

Table 1: Base Unit dip switches.

- Dip switches S1 to S4 route the LINE, EXT. MIC., TAPE, and SYSTEM inputs to either the NORMAL or EFFECTS bus. The NORMAL bus feeds the mixed input signals to the TAPE, LINE, SYSTEM, , and INFRA outputs. The EFFECTS bus signal is available at the EFFECT output where you can connect a feedback eliminator or other effects device. Connect the output of your effects device to the EFFECT IN jack on the rear panel. The processed signal is fed to the NORMAL bus. As long as no effects device is connected, the signal is routed to the NORMAL bus.
- Dip switches S5 and S6 let you activate and deactivate NOM attenuation. NOM (Number of Open Microphones) attenuation reduces the volume of the loudspeakers in a sound system depending on the number of microphones that are active at any time. The more microphones are open, the more the loudspeaker volume is reduced. S5 allows you to activate NOM attenuation for the loudspeakers on the microphone stations connected to SYSTEM outputs. S6 lets you activate NOM attenuation on the LINE OUT signal that feed the room sound system.
- Dip switch S7 allows you to select the input signal for system channel 1. To route the assigned Interpreter Station output to channel 1, set S7 to "0". To route the EXT. LANG. input to channel 1, set S7 to "1". You can use the later configuration

Section 3: CS5 BU Base Unit

for a consecutive interpreter with a hardwire or wireless microphone. Whenever there is a change in the dip switch configuration, abbreviation list will be getting downloaded which is indicated by the NOM limit LED blinking till the list gets downloaded completely.

- Dip switch S8 selects one of two microphone activation modes.
 - With S8 in position "0", a microphone will be switched on immediately on pressing the talk button ("requesting the floor") if a microphone channel is available. If no microphone channel is available, the microphone requesting the floor will be put on the waiting list.
 - With S8 in position "1", a microphone will be switched on immediately on pressing the talk button if a microphone channel is available. If no microphone channel is available, the floor request on top of the speaking list will be deleted and the last microphone requesting the floor will be added to the speaking list immediately.

3.4.3 Selecting NOM Limitation/Interpretation Channels

Set NOM LIMIT (7) to the desired ratio between the maximum number of microphones that may be open at any time and the number of channels available for interpretation. If no interpretation is needed, you may set NOM LIMIT to "63/0", allowing 63 microphones to be open simultaneously. To reduce the number of open microphones, set NOM LIMIT to a lower position. If interpretation will be provided, set NOM LIMIT for the number of interpretation channels required (e.g., "48/15" for the number of interpretation channels up to 15 and 48 open microphones).^{4 5}

3.4.4 Powering Up

1. Set up all microphone stations referring to section 4 (page 25) and make all power connections.
2. Switch power to the Base Unit ON, wait for five seconds, switch the first twenty microphone stations ON, wait for five seconds, and switch the next twenty microphone stations ON, and so on.

⁴ NOM LIMIT setting is ONLY applicable to non priority stations. NON Priority stations consist of President Station or delegate stations whose priority mode is switched ON through the Dip switch of that particular station.

⁵ NOM LIMIT can also be set remotely through CS5 confer control software, which will be overriding the NOM LIMIT set over BU. If the NOM limit is set to ZERO remotely then, the value which is set over BU will be getting evaluated for allocating the MIC. This feature will be available from V3 of the confer control software.

Section 3: CS5 BU Base Unit



Important:

- To avoid overloading your power line and causing a risk of fire when powering up, make sure never to connect more than twenty microphone stations to a common circuit with a common power switch and never switch more than twenty microphone stations ON at a time.



Important:

- When powering up for the first time or after making any changes to the system configuration, it is absolutely necessary to run the “LEARNING” routine by following through the steps 3 to 5 as mentioned below. Failing to do so will cause severe system malfunctioning!

3. Insert the **SERVICE CARD** supplied with the Base Unit into the card slot on any **CS5 VU microphone station**.
4. Press soft button 1 on the same microphone station into which you inserted the **SERVICE CARD**.
5. As soon as the display reads “**LEARNING SUCCEEDED**”, remove the **SERVICE CARD**. The Base Unit has now stored the system configuration and will load this configuration immediately after switching power ON the next time.

If you are not sure if the “LEARNING” routine has been run, run it again. This will cause no problem.



Important:

- Mark the SERVICE CARD clearly and unmistakably and keep it in a safe place. You will need to use it every time you power up a newly set up mobile system for the first time and every time you made any change to an existing (mobile or permanently installed) system configuration.



Note:



- If you lose your SERVICE CARD, order a replacement from your dealer or nearest AKG Distributor will be glad to help.

Systems with CS5 DU Microphone Stations only

- System configurations with CS5 DU stations only cannot be stored in memory. To power up such a system, simply follow steps 1 and 2 above.

Section 3: CS5 BU Base Unit

3.4.5 Setting Levels

- 1 Set up all microphone stations referring to section 4, make all power connections and switch power to the Base Unit and all ancillary equipment ON. (Steps 5 through 9 in the Getting Started Quickly manual).
- 2 Have people talk into the microphones on the microphone stations. You can set the SYSTEM control to maximum without risking overloading the amplifier input.
- 3 You can set the level controls (INPUTS ADJUST) for all other inputs you will use to maximum without risking to overload the amplifier input.
- 4 Set the level controls for all unused inputs to minimum.
- 5 Use the SPEAKERS control (8) to set the volume level for the loudspeakers on the microphone stations just high enough to get optimum intelligibility. Do not set SPEAKERS higher than to the point where the red Peak LED of the bar graph (9) will only flicker occasionally. Excessive levels may cause audible distortion.
- 6 Use the MAIN control (10) to set the volume level for the room sound system just high enough to get optimum intelligibility and avoid feedback. Do not set MAIN higher than to the point where the red Peak LED of the bar graph (11) will only flicker occasionally. Excessive levels may cause audible distortion.
- 7 Connect a pair of headphones to the  jack on the front panel for monitoring the main mix on the NORMAL bus.
The  jack accepts all standard stereo headphones with a ¼" TRS jack plug.

Set the HEADPHONE control (12) just high enough so you can comfortably monitor the main mix.



Important:

- Excessive headphone listening levels may damage your hearing. So use the HEADPHONE control with care.

Section 4: CS5 DU Delegate Station

4.1 Introduction

The CS5 DU is the basic microphone station for the CS5 conference system. It provides a microphone connection with talk button, two built-in loudspeakers, and two headphone jacks.

The loudspeakers reproduce the main mix ("floor signal") while the headphone jacks allow the user to listen to the floor signal or one of three interpreted languages.

4.2 Controls, Inputs, and Outputs

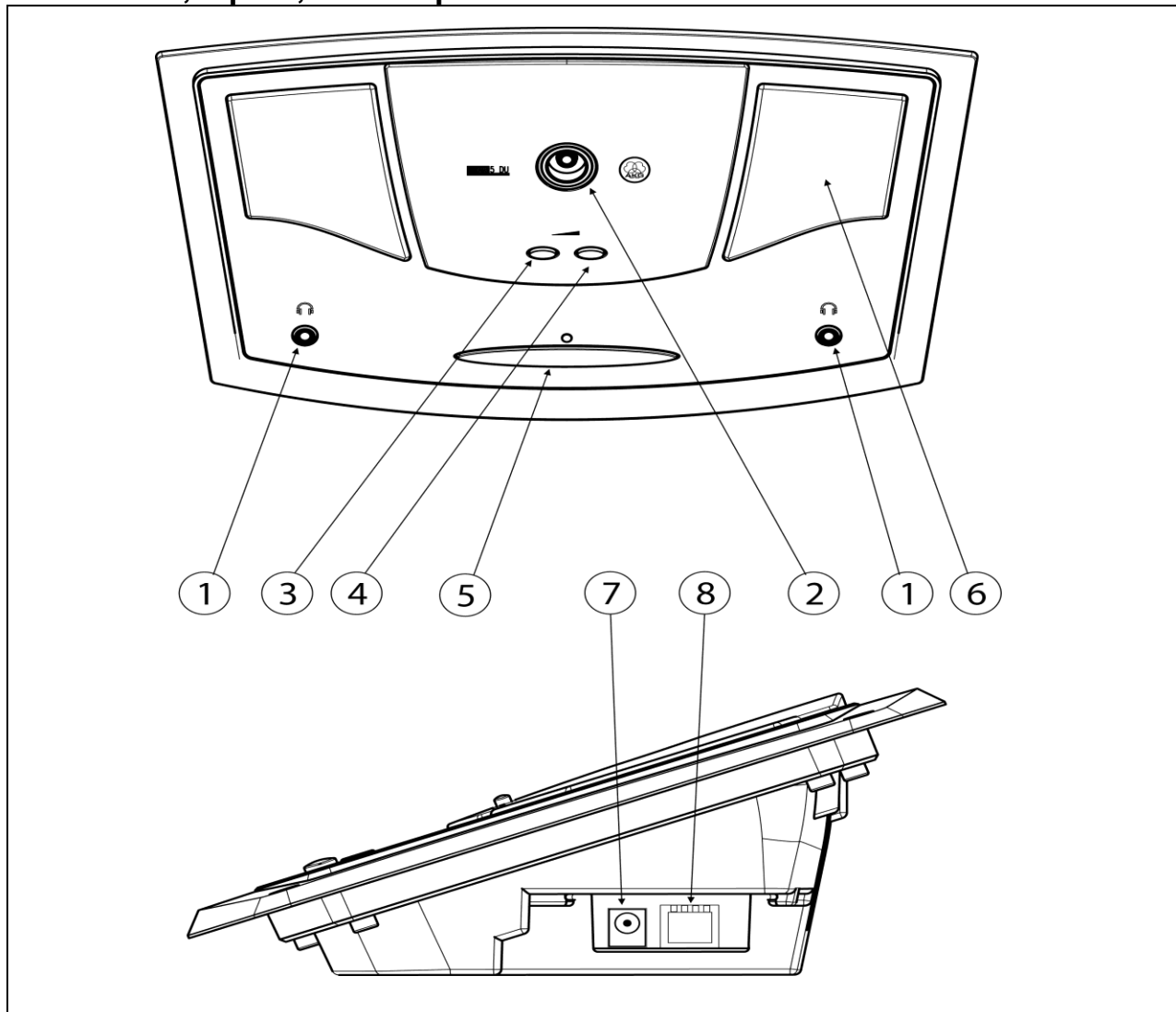



Fig. 4: Controls, inputs, and outputs on the CS5 DU.

- 1 :  Mini jack for stereo headphones.

Section 4: CS5 DU Delegate Station

2 Microphone input for connecting any of the gooseneck microphones listed in section 2

3-4 Volume control buttons: The UP button (4) increases and the DOWN button (3) decreases the volume of the built in speakers or headphones connected to the microphone station.

- If no headphones are connected to the microphone station, the volume control buttons set the volume of the built in loudspeakers.
- If a single pair of headphones is connected to either headphone jack, the volume control buttons set the volume for that pair of headphones.
- If headphones are connected to both headphone jacks, the volume control buttons set the volume of both headphone channels.



Note:

When the microphone is open, the volume of the loudspeakers will be attenuated by a specific amount depending on the polar pattern of the microphone used. The headphones volume will not be affected.

Refer to
Fig.4 on
Page 25

5 Talk button: Pressing the talk button once activates the microphone. The status LED above the button will be lit. Pressing the talk button again switches the microphone off. The status LED above the button will go out. If no microphone channel is available, the microphone will not be activated before a channel becomes available. The status LED will be flashing. Pressing the talk button again cancels the floor request and the status LED will go out. The talk button also allows simple two-way (aye/no) voting (refer to section 5.4.2).

6 Loudspeakers.

7 DC input for connecting a CS5 PS 12 power supply.

8 System port: RJ45 connector for CS5 MK... LAN cables. (Refer to section 2.2 for example wiring diagrams.)

4.3 Setting Up

4.3.1 Making Connections

Fig.4 on
Page 25

1. Screw the microphone capsule on the gooseneck.
2. Screw the gooseneck into the microphone input (2).
3. Use the appropriate CS5 MK... cables to connect the system ports on the microphone station to the system ports on the preceding and subsequent microphone stations.

Section 4: CS5 DU Delegate Station

4.3.2 Selecting Operating Modes



Important:

- To avoid malfunctioning, do not change any dip switch settings on the Base Unit or any microphone station while power to the system is ON!

Section 4: CS5 DU Delegate Station

Table 2: CS5 DU dip switches.

Dip switches	Function	Switch positions		
S1, S2	Match microphone station audio input to microphone output signal.			
S3	Allowed to Vote	0	1	
		Allowed to Vote	Not Allowed to Vote	
		0	1	
S4	Microphone muting on priority request:	Microphone can be muted.	Microphone will not be muted.	
S5, S6	Switch left-hand phones output to channel (language selection):	Channel	S5	S6
		Floor	0	0
		CH 1 or EXT. LANG.	1	0
		CH 2	0	1
		CH 3	1	1
S7, S8	Switch right-hand phones output to channel (language selection):			

1. Referring to Table 2 above, set S1 and S2 for the microphone capsule you are going to connect to the microphone station.

The settings of S1-S2 determine the frequency response and gain of the audio section as well as the amount of gain reduction that is applied to the loudspeaker amplifier as soon as the microphone opens. Therefore, microphone stations with unidirectional microphone capsules allow delegates to hear other talkers on the built-in loudspeakers even while the microphone is open.



Important:

- The amount of gain reduction applied to a cardioid capsule is rather low while hyper cardioid and shotgun microphones will be attenuated more significantly. To avoid feedback problems, make sure to set S1-S2 to the correct positions as per Table 2 on page 26.

2. Set the other dip switches to select the microphone priority/muting mode and select the input signals for the left and right-hand headphone outputs.

3. The settings of S3 will be determining the status of the device, to allow/not to allow to vote during an opinion poll/voting process during a conference.

Section 5: CS5 VU Voting/Chairperson Station

5.1 Introduction

The CS5 VU can be configured either as a delegate station with a voting function or as a chairperson station with voting, priority, changing the operating mode functions and to enable waiting stations in the queue. Like the CS5 DU, it provides a microphone connection, talk button, two built-in loudspeakers, and two headphone jacks.

The loudspeakers reproduce the main mix ("floor signal") while the headphone jacks allow the user to listen to the floor signal or one of the interpretation languages.

In addition, the CS5 VU incorporates a chip card reader for user identification by conference control software. A liquid crystal display and five soft buttons, which allow the user to call the meeting to order, initiate ballots, cast their vote, select languages for the headphone outputs; change the operating modes, etc.

5.2 Control Panel, Inputs, and Outputs

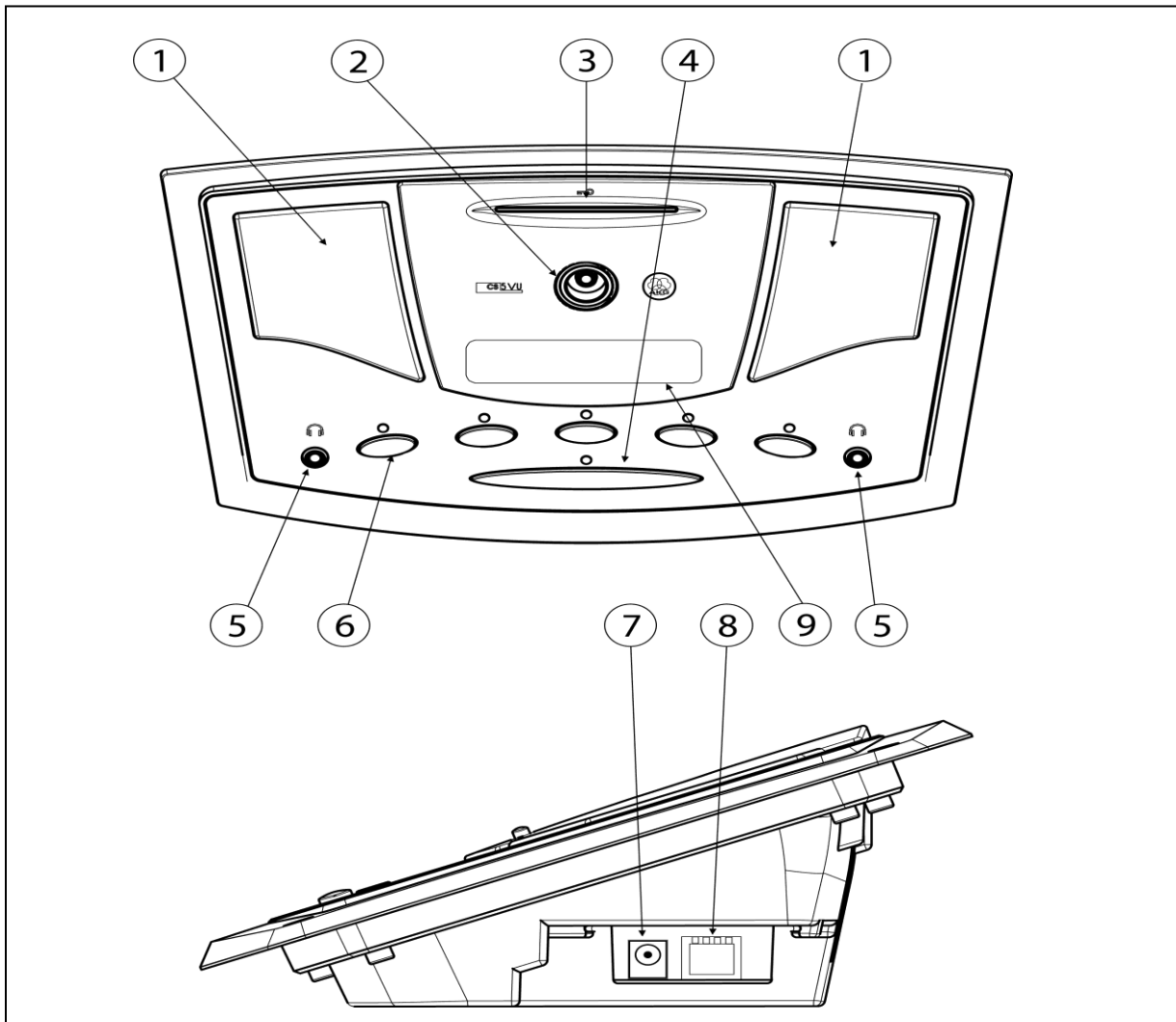

Fig. 5: CS5 VU control panel, inputs and outputs.

Section 5: CS5 VU Voting/Chairperson Station

- 1 **Loud speakers.**
- 2 **Microphone input** for connecting any of the gooseneck microphones listed in section 2



Note:

When the microphone is open, the volume of the loudspeakers will be attenuated by a specific amount depending on the polar pattern of the microphone used. The headphones volume will not be affected.

- 3 **Chip card slot**
- 4 **Talk button:** Basically, pressing the talk button once activates the microphone and the status LED above the button will be lit. Pressing the talk button again switches the microphone off and the status LED above the button will go out.
- 5  : Mini jack for stereo headphones.
- 6 **Soft buttons:** These buttons control the functions assigned to them in the various menus shown on the display. The buttons are assigned to numbers 1 through 5 in the lower display line from left to right.
- 7 **DC input** for connecting a CS5 PS 12 power supply.
- 8 **System port:** RJ45 connector for CS5 MK... LAN cables. (Refer to section 2.2 for example wiring diagrams.)
- 9 **Display:** Two-line liquid-crystal display indicating the main menu for selecting functions and the submenus for setting the parameters for each function.

Section 5: CS5 VU Voting/Chairperson Station

5.3 Setting Up

5.3.1 Making Connections

Fig.5 on
Page 29

- Screw the microphone capsule on the gooseneck.
- Screw the gooseneck into the microphone input (2).
- Use the appropriate CS5 MK... cables to connect the system ports on the microphone station to the system ports on the preceding and subsequent microphone stations.

5.3.2 Selecting Operating Modes



Important:

- To avoid malfunctioning, do not change any dip switch settings on the Base Unit or any microphone station while power to the system is ON!

Dip switches	Function	Switch positions	
S1, S2	Match microphone station audio input to microphone output signal.		
S3	Unuse		
		0	1
S4	Microphone muting on priority request:	Microphone can be muted.	Microphone will not be muted.
S5	Test mode:	Normal operating mode as selected	Test mode: Display indicates data
S6	Configuration:	Last user-selected configuration	Factory default configuration
S7	Voting from delegate station:	Enabled	Disabled
S8	Voting Station operating mode:	DELEGATE	PRESIDENT

Table 3: CS5 VU dip switches.

1. Referring to Table 3 above, set S1 and S2 for the microphone capsule you are going to connect to the microphone station.
The settings of S1-S2 determine the gain of the audio section as well as the amount of gain reduction that is applied to the loudspeaker amplifier as soon as the microphone opens. Therefore, microphone stations with unidirectional microphone capsules allow delegates to hear other talkers on the built-in loudspeakers even while the microphone is open.



Important:

- To avoid feedback problems, make sure to set S1 and S2 to the correct positions as per Table 3 above.

Section 5: CS5 VU Voting/Chairperson Station

2. Set the other dip switches to select the microphone priority/muting mode and select the input signals for the left and right-hand headphone outputs.
3. The settings of S4 will be determining the right's for the device to allow/not to allow speaking.
4. The settings of S5 will be determining, whether the system will be running in test mode or the mode which is enabled as using dip switch S8.
5. The settings of S6 will be determining to load the configuration for the device after the last power cycle reset.
6. The settings of S7 will be determining to enable/disable the right to vote from that particular station.
7. The settings of S8 will be determining, whether that station is a normal delegate with normal delegate operations or a president station operations.

Section 5: CS5 VU Voting/Chairperson Station

5.3.3 DELEGATE Mode

If you have set dip switch S8 for DELEGATE mode, the Delegate main menu will appear on the display upon powering up.

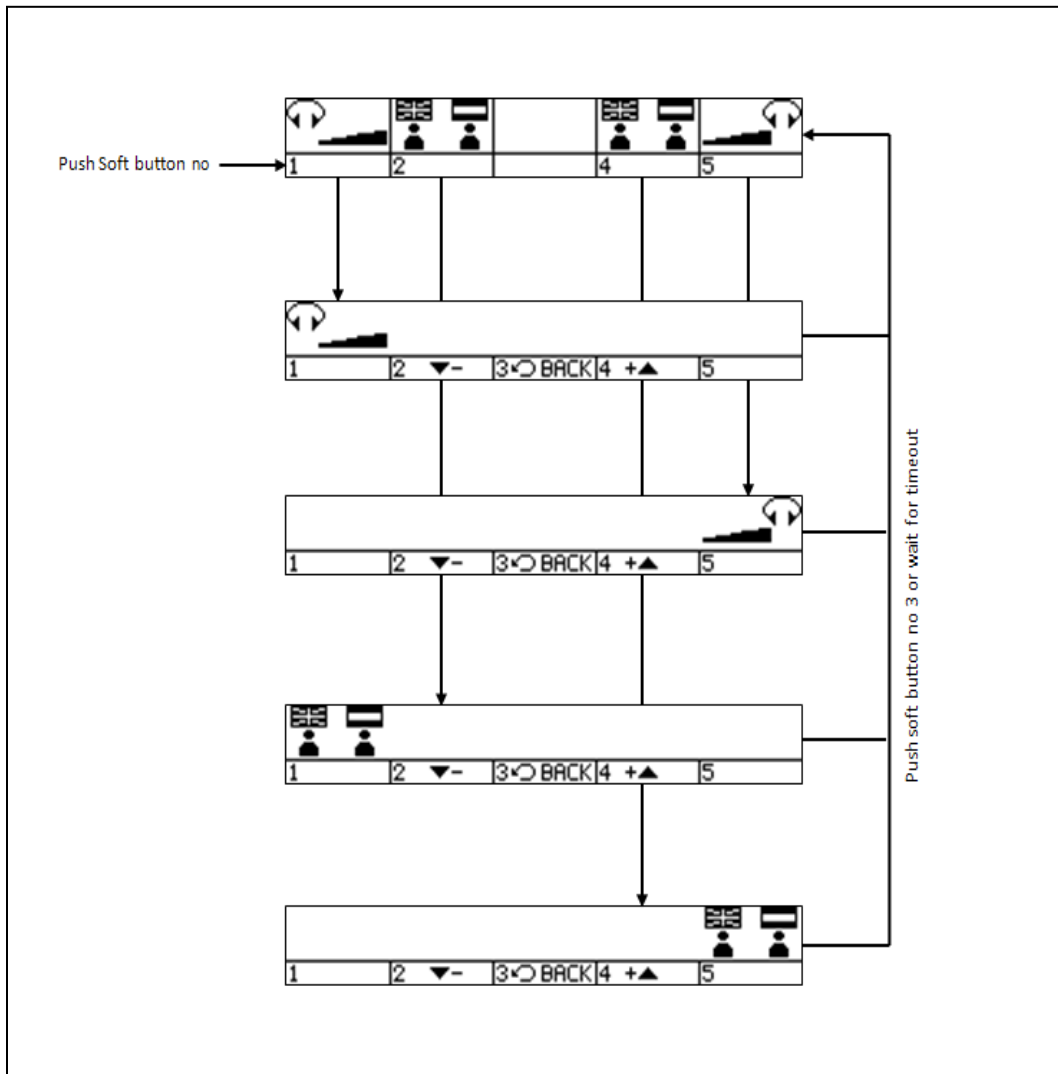

Fig. 6: Delegate menu and selectable submenus.

1. Press soft button 1 to select the volume control for the left-hand headphone output. Press soft buttons 2 and 4 to decrease (-) or increase (+) the volume. A bar graph indicates the current setting. Press soft button 3 (BACK) to return to the main menu.
2. Press soft button 2 to call up the language selection submenu for the left-hand headphone output. Press soft buttons 2 and 4 to select the desired language. Channel 0 carries the floor signal, channels 1-63 are assigned to the interpreted languages listed in Table 4 in section [6.3.4](#) on page 55. Press soft button 3 (BACK) to return to the main menu.

Section 5: CS5 VU Voting/Chairperson Station

3. Press soft button 4 to call up the language selection submenu for the right-hand headphone output. Press soft buttons 2 and 4 to select the desired language. Channel 0 carries the floor signal, channels 1-63 are assigned to the interpreted languages listed in Table 4 in section [6.3.4](#) on page 55. Press soft button 3 (BACK) to return to the main menu.
4. Press soft button 5 to select the volume control for the right-hand headphone output. Press soft buttons 2 and 4 to decrease (2) or increase (4) the volume. A bar graph indicates the current setting. Press soft button 3 (BACK) to return to the main menu.

Section 5: CS5 VU Voting/Chairperson Station

5.3.4 PRESIDENT Mode

If you have set dip switch S8 for PRESIDENT mode, the President main menu will appear on the display upon powering up.

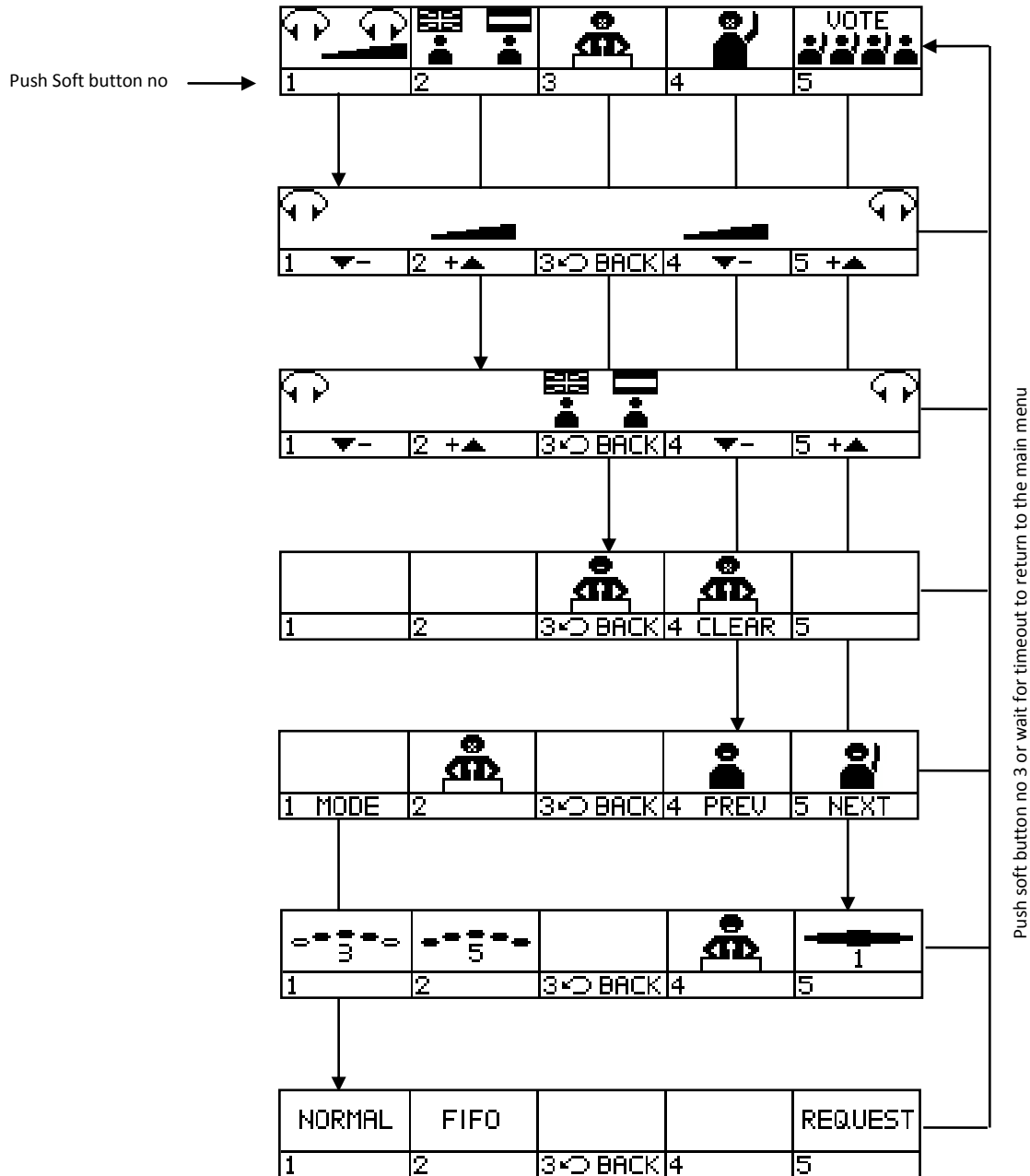

Fig. 7: President Menu and selectable submenus.

Section 5: CS5 VU Voting/Chairperson Station

1. Press soft button 1 to select the volume control for the left and right-hand headphone outputs. Press soft buttons 1 and 2 to decrease (-) or increase (+) the volume for the left-hand headphones, buttons 4 and 5 to decrease (-) or increase (+) the volume for the right-hand headphones. Two bar graphs indicate the current settings. Press soft button 3 (BACK) to return to the main menu.
2. Press soft button 2 to call up the language selection submenu for the left and right-hand headphone outputs. Press soft buttons 1 and 2 to select the desired language for the left-hand headphones, buttons 4 and 5 to select the desired language for the right-hand headphones. Channel 0 carries the floor signal, Channel's 1-63 are assigned to the interpreted languages listed in Table 4 in section [6.3.4](#) on page 55. Press soft button 3 (BACK) to return to the main menu.
3. Press soft button 3 to set the microphone station to priority mode. In priority mode, pressing the talk button once initiates the priority mode where only president station or priority station can have the word and mutes all other microphone stations where priority muting has been enabled. To restore the priority mode to the previous state press soft button 3 (BACK) and to quit priority mode and return to the main menu, press soft button 4 (CLEAR).
4. Press soft button 4 to change the mode of the system and to activate the Next/Prev speaker. Refer to section 5.6 below
 - Press soft button 1, to change the operating mode of the system.
 - Press soft button 1 to change the mode of the system to NORMAL.
 - Press soft button 2 to change the mode of the system to FIFO.
 - Press soft button 5 to change the mode of the system to REQUEST.
 - Press soft button 5 (NEXT) to activate the first speaker in the waiting list.
 - Press soft button 4 (PREV) to give the word back to the previous speaker (only one speaker) who just concluded his speech.
5. Press soft button 5 to initiate a ballot or opinion poll. Refer to section 5.4 below.
6. To return to the main menu, press soft button 3 (BACK).

Section 5: CS5 VU Voting/Chairperson Station

5.4 Voting/Polling



Important:

- If anything goes wrong while a ballot or poll is in progress, the display will go dark (in case of a power failure) or show "VOTING FAILED". Voting/polling data may be lost or corrupted.
- To ensure correct results, always repeat the entire ballot or poll once the problem has been corrected.

5.4.1 Controlling a Ballot or Opinion Poll (PRESIDENT Mode)

• Instruct the president of the meeting how to control a complete voting or polling procedure:

- 1) From the President main menu, press soft button 5 (VOTE) to call up the voting control menu:



- 2)

a) To start a two-way (Yes/No) vote, press soft button 5. This allows two-way voting from both CS5 VU and CS5 DU microphone stations. Now, delegates may cast their vote by pressing the MIC button as long as "TIME LEFT" is shown on the display. You can press soft button 5 (ABORT) to stop the procedure and return to the voting control menu. Once the vote is casted, screen will be getting inverted on the delegate units having LCD which indicates that vote got recorded and on the delegate units without LCD, there will be an indication of the MIC button LED going ON (green color) a moment (this is for maintaining secrecy) and going OFF. If the vote is taken back by pressing the MIC button, the indication gets changed on the units having LCD and on stations without LCD will be indicated by the LED ON and OFF (RED color) for a moment (this is for maintaining secrecy) indicating that the vote is taken back.

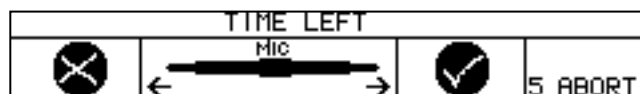

Section 5: CS5 VU Voting/Chairperson Station

b) To start a three-way (No/Abstention/Yes) ballot, press soft button 1 and the display will change like this:



The delegates may now cast their votes as long as "TIME LEFT" is shown on the display, you can press soft button 5 (ABORT) to stop the procedure and return to the voting control menu. Once the vote is casted, screen will be getting inverted on these stations which indicates, that vote got recorded against that particular option. User can change his/her casted vote to any other option till "TIME LEFT" is shown on the display or can press the same soft button again to remove his casted voted.

c) To start an opinion poll (five options), press soft button 2. The display will change like this:



The delegates may now cast their votes. As long as "TIME LEFT" is shown on the display. You can press soft buttons 1 and 5 simultaneously (ABORT) to stop the procedure and return to the voting control menu. Once the vote is casted, screen will be getting inverted on these stations which indicates, that vote got recorded against that particular option. User can change his/her casted vote to any other option till "TIME LEFT" is shown on the display or can press the same soft button again to remove his casted voted.

The delegates may now cast their votes. Refer to section 5.4.2 on page 27.

3) Once the time out happens, all the votes are counted automatically and the below screen appears on the display (results shown below are examples):



4) When the counting is done, the display will change like this for two way (Yes/No) voting...

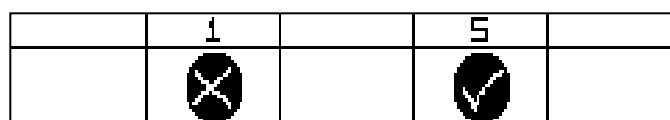

Section 5: CS5 VU Voting/Chairperson Station

...or like this for 3 way voting

	13	25	32	
1	2	3	4	5

...or like this for 5 way voting

	3	15	2	43	21
1	2	3	4	5	

The votes which have been counted will be shown on the top line on each CS5 VU microphone station indicating the results of the voting.

- 5) Press any button to return to the President main menu.

5.4.2 Voting in DELEGATE Mode

Instruct the delegates how to cast their votes:

- 1) When the president starts a ballot or opinion poll, the display on each delegate station registered for voting changes like this...

...for two way (Yes/No) voting like this



...like this for three-way voting or



...like this for five-way voting



Note:

When the microphone is open, the volume of the loudspeakers will be attenuated by a specific amount depending on the polar pattern of the microphone used. The headphones volume will not be affected.

Section 5: CS5 VU Voting/Chairperson Station⁶

2)

2a. Press the appropriate soft button to cast your vote.

2b. Simple Yes/No voting can be done from both CS5 VU and CS5 DU microphone stations:

- To vote "Yes", press the talk button when the chairperson asks you to do so.
- To vote "No", either you can ignore the chairperson's request by not pressing any button until the voting time has elapsed or can press the talk button twice until red led is shown for one second.

3) As soon as all delegates have pressed their voting buttons, the votes are counted automatically and this screen appears on the display:

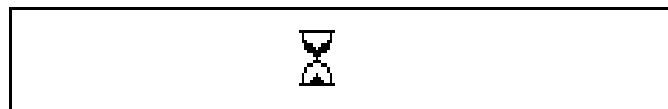

4. When the counting is done, the display will change like this...

	1		5	
	✗		✓	

...or like this

	13	25	32	
1	✗	☹	✓	5

...or like this

	3	15	2	43	21
1	✗✗	✗	☹	✓	✓✓

5. Press any soft button to return to the Delegate main menu.

⁶ Using the new Confer control software CCV2, we can have 1 button to 5 button voting process. Kindly refer ConferControl software manual for more details.

Section 5: CS5 VU Voting/Chairperson Station

5.4.3 Voting Feedback

VOTING UNITS:

For all the type of voting's, the picture on the LCD gets inverted indicating, that particular option is casted for the vote/poll. This helps in secrecy till the voting/polling results are evaluated.

DELEGATE UNITS:

These units are only allowed to take part only in One button voting as LCD screen is not present for having the rest of the voting types. Participant will make use of the MIC button, to cast his/her vote. Green LED will be ON for a moment that the vote is registered. If the participant is uncast his/her vote, again he/she needs to press the same MIC button, and a red LED will be ON for a moment.

Section 5: CS5 VU Voting/Chairperson Station

5.5 Chip Card Identification

Chip card identification is only available in a computer controlled system and the identification system only accepts AKG chip cards. The chip card reader and control software check the identity of the person using the microphone station as well as their priority and voting rights, allowing votes to be weighted or classified. This system also allows holders of AKG chip cards to exercise their rights not only from their assigned microphone stations, but from any CS5 VU microphone station in the conference system.



Note:

To assign chip cards to persons, enter each person's data into the database in the CS5 Confer Control software. For details, refer to the Confer Control Operating Manual.

- **Instruct users how to identify themselves to the system.**

1. Insert the chip card into the chip card reader slot with the contacts pointing toward the slot as shown on the display:

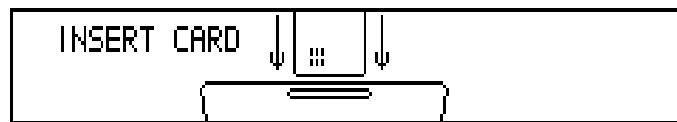

The main menu appears on the display. If you inserted the card the wrong way, or if you inserted an incompatible card, a warning message ("WRONG CARD") will appear on the display:

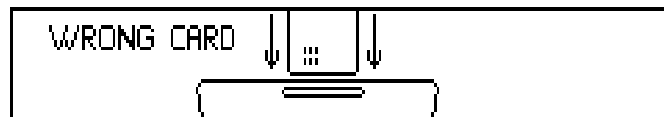

Important:

- Inserting any card other than an AKG chip card causes malfunctioning and may even damage the card or the equipment.

2. Remove the chip card once the session is over.



Note:

If two persons share a single CS5 VU, both persons can vote by taking turns using their chip cards and proceeding as describe in sections 5.4 and 5.5 above.

Section 5: CS5 VU Voting/Chairperson Station



Note:

- When president card is inserted/removed while the system is in voting the unit will react only after voting gets completed or aborted.
- When president card is inserted/removed from the system which initiated priority the system will directly come out of priority state.

Section 5: CS5 VU Voting/Chairperson Station

5.6 Operating modes of the system⁷



Important:

- Once the operating mode of the system is changed, the same information is sent to BU, which will tell that the mode of the system got changed.
- BU then transmits the operating mode information to the complete ring.

5.6.1 NORMAL mode⁸

In this mode of operation, priority stations will always be getting the word, the moment it is requested for irrespective of the NOM limit. If there is no free channel, then the word will be taken away from that speaker who is having lower priority and has been speaking for the longest. If there is a free channel then the word requesting participant automatically gets the word. If there is no free channel available the word requesting participant is added to the waiting list. If a channel is freed then the participant, who is on the first place on the waiting list will automatically get the word.

5.6.2 FIFO mode⁹

In this mode of operation, priority stations will always be getting the word, the moment it is requested for irrespective of the NOM limit. If there is no free channel, then the word will be taken away from that speaker who is having lower priority and has been speaking for the longest. If there is a free channel then the word requesting participant automatically gets the word. If there is no free channel available then the word will be taken away from that speaker, who has been speaking for the longest.

⁷ Operating mode of the system can be either be initiated through the president unit, or by changing the dip switch setting over BU. Any change in the dip switch setting will be over riding the mode setting which was set from president unit.

⁸ This mode can be selectable from the president unit by going inside the menu selection screen as well as from the dip switch setting over BU. First delegate in the waiting list will be blinking its Arm LED.

⁹ This mode can be selectable from the president unit by going inside the menu selection screen as well as from the dip switch setting over BU.

Section 5: CS5 VU Voting/Chairperson Station

5.6.3 REQUEST mode¹⁰

In this mode of operation, in case of a speech is initiated by a participant without priority, then the participant will NOT get the word immediately, instead that station will be going into the wait state. President will be having an option to give the word to a particular participant by selecting either the Next¹¹ or Prev^{12 13 14} options using the soft buttons 5 or 4 respectively.

¹⁰ This mode can only be selectable only from the president unit by going inside the menu selection screen. First person in the waiting list will be blinking its Arm LED.

¹¹ This will be making the first next speaker in the wait list to get the MIC immediately if NOM limit is available. If NOM limit is not available, the station will be getting the MIC by kicking out the longest active speaker → Which will become the previous speaker.

¹² This trigger will make that station to get its MIC, which lost the MIC recently, which was taken by some other station with the next trigger command.

¹³ This trigger will have the effect only in NORMAL and REQUEST mode only.

¹⁴ Only one previous speaker can be revoked by this trigger. Multiple triggers will make those stations to toggle their MIC state, which got its MIC and lost its MIC recently.

Section 6: CS5 IU Interpreter Station

6.1 Introduction

The CS5 IU adds interpretation capabilities to the CS5 conference system. It provides inputs and outputs for a gooseneck microphone and headphones or a headset, a built-in loudspeaker, source and target language selectors, a microphone switch, cough button, "slow" signal button, and a signal button for requesting a technician's assistance.

6.2 Control Panel, Inputs, and Outputs

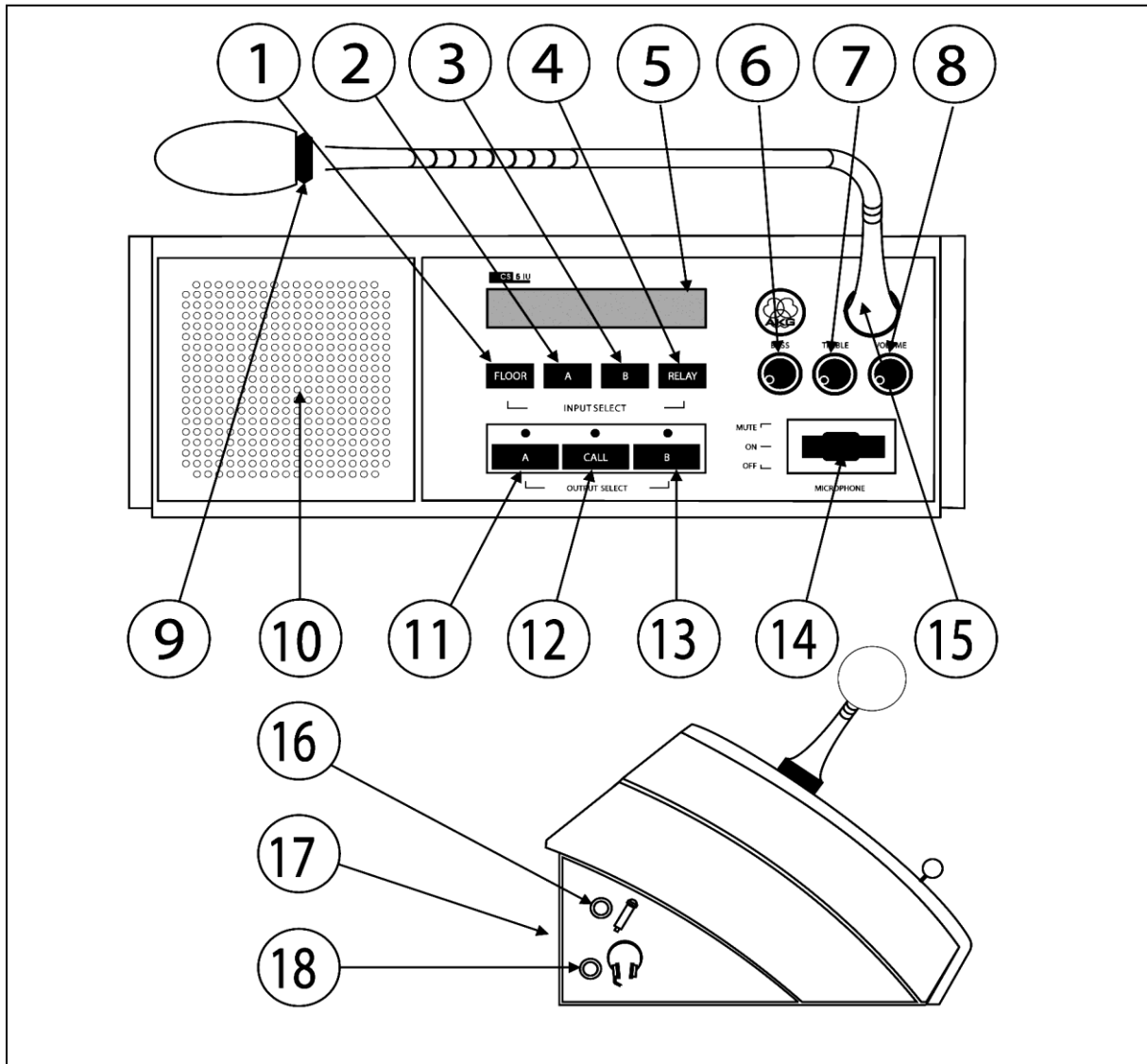

Fig. 8: CS5 IU control panel, inputs, and outputs.

Section 6: CS5 IU Interpreter Station

INPUT SELECT: These four keys select the source language signal that is routed to the headphone output.

- 1 **FLOOR:** Selects the floor (main mix) signal.
- 2 **A:** Selects the next item from a list.
- 3 **B:** Selects the previous item from a list.
- 4 **RELAY:** Selects the relay-language channel specified by the organizer or chief interpreter.
- 5 **Backlit LC display.**
- 6 **BASS:** Cuts/boosts the low-frequency range of the headphone or loudspeaker signal.
- 7 **TREBLE:** Cuts/boosts the high-frequency range of the headphone or loudspeaker signal.
- 8 **VOLUME:** Sets the volume level of the headphone or loudspeaker signal.
- 9 **Microphone status LED:** Indicates the current operating status of the microphone:
 - **Lit:** microphone is open (MICROPHONE switch (14) set to "ON").
 - **Dark:** microphone is off or muted (MICROPHONE switch (14) set to "OFF" or "MUTE").
- 10 **Loudspeaker:** The loudspeaker is automatically muted when a pair of headphones is connected to the headphone output (18). When no headphones are connected to the Interpreter Station, the loudspeaker reproduces the selected incoming signal. The rotary controls (6), (7), and (8) adjust the loudspeaker signal.

Fig.8 on
Page 46

OUTPUT SELECT: These keys select one of two pre-selected target language channels and allow the interpreter to request the talker to speak more slowly or to call a technician for assistance (provided a technician is available and this works **only** with application software).

- 11 **A:** Routes the microphone signal to the target-language channel specified for this booth.
- 12 **CALL:** This key has two functions:
 - **Pressing <CALL> momentarily** sends a "speak slowly" signal to the talker. The red LED above the <CALL> key and the LED on the microphone arm of the talker's Delegate Station will flash for about 5 seconds. The display (5) shows the message "SENDING SLOWLY PLEASE". Pressing <CALL> momentarily again before the five seconds have elapsed will stop the signal.

Section 6: CS5 IU Interpreter Station

- **Holding down <CALL> for at least 3 seconds** activates an appropriate message on the computer monitor alerting the technician that an interpreter needs assistance, which can be disabled by the technician by clicking on that IU which he is attending by clicking that IU number on the application software. To cancel the signal from the unit itself, hold down the <CALL> button again for about 3 seconds.
- 13 **B:** Routes the microphone signal to the source-language channel specified for this booth.
- 14 **MICROPHONE:** This toggle switch provides three positions:
- **OFF:** The microphone is off and the LED on the microphone arm is dark.
 - **ON:** The microphone is open and the LED on the microphone arm is lit.
 - **MUTE (cough button function):** The microphone is muted and the LED on the microphone arm is dark for as long as you hold the switch in the MUTE position. The switch will return to the ON (center) position as soon as you release the switch.
- 15 **Microphone input.**
- 16 **External microphone input:** This mini jack allows you to connect the microphone of a headset if the client specifies headsets for the interpreters instead of microphone arms and separate headphones.
- 17 **System port:** RJ45 connector for CS5 MK... LAN cables. (Refer to section 2.2 for example wiring diagrams.)
- 18 : Mini jack for stereo headphones.

6.3 Setting Up



Important:

- According to international practice as specified by the AIIC, each interpretation booth must provide two Interpreter Stations because interpreters never work alone. Having an interpreter work alone in a booth would be unethical.



Note:

In the following sections, the terms "source language", "target language", and "relay language" will be used frequently. The source language is the language an interpreter translates into another language. That other language is called the target language. A relay language is a target language that is used as a source language by another interpreter if that interpreter is not qualified to interpret the original source language.

Section 6: CS5 IU Interpreter Station

6.3.1 Making Connections

1. Screw the microphone capsule on the gooseneck.
2. Screw the gooseneck into the microphone input.
3. Use the appropriate CS5 MK... cables to connect the system ports on the microphone station to the system ports on the preceding and subsequent microphone stations.

6.3.2 Setting up Interpreter Station

The screen of the interpreters after every firmware upgrade will be changing something like below.

```
>FLOOR<                                     ???  
  
???                                     <<<OUT                                     ???
```

For setting up the Interpretation station, we need to enter into the service menu, which can be achieved by a key combination, which is explained below.

- To enter to service menu, set the MICROPHONE switch to "OFF" position.
- Once the microphone switch is in "OFF" position, Press <FLOOR> + <CALL> + <RELAY> simultaneously to enter service mode and the display on the station will be changed as shown below.

```
                SERVICE MENU  
                EXIT WITHOUT SAVING  
<<PREV          ( )          NEXT>>
```

If the user doesn't want to save the configuration for the interpreter station, user can click on the buttons "A" and "B" under INPUT SELECT simultaneously, which will exit the service menu without saving the configuration for this interpreter station.

Section 6: CS5 IU Interpreter Station

Once the above screen is shown on the LCD, proceeding to next item, can be achieved by clicking the NEXT button (using RELAY button) and the display changes as shown below.

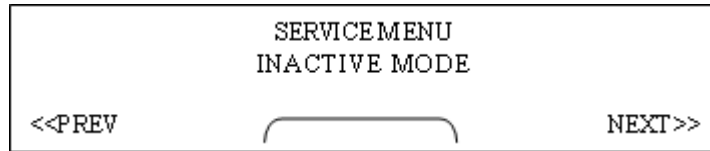

We can make that station as inactive by pressing the keys A and B simultaneously. By making that station as Inactive station, implies that station will be part of ring doing nothing and will not be occupying any channels as well. This can be used, if we doesn't want to change the ring configuration and do not want to use interpretation station for that conference.

To proceed to the next item, click NEXT button and the display changes as shown below.



Using this menu, we can set the interpretation station as twin to other interpretation station. In order to set up in twin mode, click on the buttons "A" or "B" under INPUT SELECT, this will be showing the interpreters which are present in the ring. Selecting the number of the interpreter station will be making this interpreter to be in twin with the other interpreter station. This will make to act both the interpreter stations to act in the same way, and only one will be active one at a time.

To proceed to the next item, click NEXT button and the display changes as shown below.

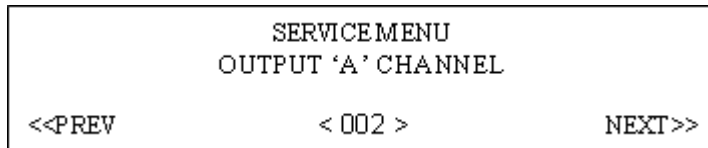

This menu will help us to select the channel number for the OUTPUT A, which routes the microphone signal to the target language specified for this booth. Click on the buttons "A" or "B" under INPUT SELECT for changing the channel number for OUTPUT A.

To proceed to the next item, click NEXT button and the display changes as shown below.

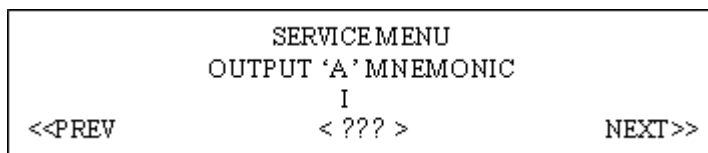

Section 6: CS5 IU Interpreter Station

This screen enables us to set any of the language (as defined in Table 4) for this particular IU. Roman "1" at the first place indicates that the language will be changing first alphabet wise. Clicking on the button B will make the screen to change as below where, we can change the language starting with that alphabet letter.

```
          SERVICE MENU
        OUTPUT 'A' MNEMONIC
              II
<<PREV      < ??? >      NEXT>>
```

Once we are done with setting the language for OUTPUT A, click on the NEXT button and the display changes as shown below.

```
          SERVICE MENU
        OUTPUT 'B' (RELAY LANGUAGE) CHANNEL
<<PREV      < 000 >      NEXT>>
```

This menu will help us to select the channel number for the OUTPUT B, which routes the microphone signal to the target language specified for this booth. Click on the buttons "A" or "B" under INPUT SELECT for changing the channel number for OUTPUT B.

To proceed to the next item, click NEXT button and the display changes as shown below.

```
          SERVICE MENU
        OUTPUT 'B'(RELAY LANGUAGE) MNEMONIC
              I
<<PREV      < ??? >      NEXT>>
```

This screen enables us to set any of the language (as defined in Table 4) for this particular IU. Roman "1" at the first place indicates that the language will be changing first alphabet wise. Clicking on the button B will make the screen to change as below where, we can change the language starting with that alphabet letter.

```
          SERVICE MENU
        OUTPUT 'B'(RELAY LANGUAGE) MNEMONIC
              II
<<PREV      < ??? >      NEXT>>
```

Section 6: CS5 IU Interpreter Station

To proceed to the next item, click NEXT button and the display changes as shown below.



This menu helps us in setting up the Interpreter stations in Inter-relay mode, where there are more than one RELAY language which needs an interpretation. Click on the buttons "A" or "B" under INPUT SELECT, this will be showing the interpreters which are present in the ring. Selecting the number of the interpreter station will be making this interpreter which needs to be in inter-relay with the other interpreter station. This will make to have the interpretation of the relay languages, which are using in the conference.

To proceed to the next item, click NEXT button and the display changes as shown below.

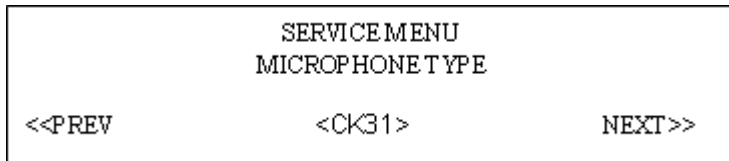

Using this menu, we can select the microphone capsule type, which is being used with that interpreter station. To proceed to the next item, click NEXT button and the display changes as shown below.

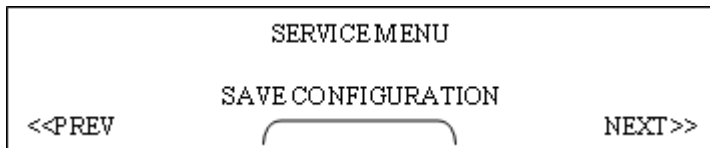

Once, we have configured all the settings for the interpretations, Click on the buttons "A" and "B" under INPUT SELECT simultaneously, which will save the configuration for this interpreter station and at the same time, the interpreter will come out of the service menu as well.

Section 6: CS5 IU Interpreter Station

To make the Interpreter station, working correctly, Switch ON the **MICROPHONE** button to ON state after saving all the parameters.



Important:

- Be sure to assign a unique address to each Interpreter Station. Use consecutive numbers starting with "1". Assigning the same address to more than one Interpreter Station would cause system malfunction.

Assign one odd and one even number to the Interpreter Stations in each booth, starting with "1", for instance, 1-2 (booth no. 1), 3-4 (booth no. 2), 5-6 (booth no. 3), etc. Make sure that the odd number is lower than the even number in each booth.

1. Select target language channels: refer to section 6.3.3 below.
2. Repeat steps 1-4 above for each Interpreter Station.
3. To leave service mode and return to normal mode without doing any changes, press <FLOOR> + <CALL> + <RELAY> again or do an "Exit without Saving" operation.

6.3.3 Example for Selecting Target Language Channels

- On your list of language pairs, assign one audio channel to each target language (e.g., channel 1 -> English, channel 2 -> French, etc.).
- Assign each of these channel numbers to one interpretation booth (e.g. booth no. 1 -> English, booth no. 2 -> French, etc.). If a relay language has been specified, assign a channel number to the relay language. Invariably, the relay language will be identical to one of the target languages.
- Route output A on each Interpreter Station in the same booth to the same language channel (e.g., select channel 1 (English) for output A on each Interpreter Station in booth 1, channel 2 (French) for output A on each Interpreter Station in booth 2, etc.)
- Route output B on each Interpreter Station in each booth to the language channel number assigned to the relay language (e.g., channel 3 for Italian).

To select output channels,

1. In service mode, press FLOOR or RELAY to call up the screen which shows the information about the channel number.



Note:

If you have quit service mode, switch the microphone off and press <FLOOR> + <CALL> + <RELAY> simultaneously to enter service mode, then use <RELAY> or <FLOOR> to call up channel number selection screen.

Section 6: CS5 IU Interpreter Station

2. Press <INPUT/A> to increase the channel number and <INPUT/B> to decrease the channel number.
3. Press <RELAY> to select the name of the language ("OUTPUT 'A' MNEMONIC") you assigned to the channel number you just selected. Refer to section 6.3.5 for a list of languages and their abbreviations available on the CS5 IU.
4. Press <RELAY> to call up the language selection menu for output B ("OUTPUT 'B' CHANNEL").
5. Press <INPUT/A> and <INPUT/B> to select the channel number you assigned to the relay language.
6. Press <RELAY> to select the name of the language ("OUTPUT 'B' MNEMONIC") you assigned to the relay channel. Refer to section 6.3.5 for a list of languages and their abbreviations available on the CS5 IU.
7. Repeat steps 1-7 above for each pair of Interpreter Stations.



Note:

You cannot leave the service menu before having saved your settings in the "SAVE CONFIGURATION" screen.

Section 6: CS5 IU Interpreter Station

6.3.4 List of Available Language Names

Abbreviation	Language	Abbreviation	Language	Abbreviation	Language
ALB	ALBANIAN	GEO	GEORGIAN	POL	POLISH
ARA	ARABIC	GER	GERMAN	POR	PORTUGUESE
ARC	ARAMAIC	GRE	GREEK	RUM	ROMANIAN
ARM	ARMENIAN	HEB	HEBREW	RUS	RUSSIAN
AZE	AZERBAIJANI	HUN	HUNGARIAN	SER	SERBIAN
BUL	BULGARIAN	ISL	ICELANDIC	SLO	SLOVAK
CHI	CHINESE	GAI	IRISH	SLV	SLOVENIAN
CRO	CROATIAN	ITA	ITALIAN	SPA	SPANISH
CES	CZECH	JPN	JAPANESE	SUX	SUMERIAN
DAN	DANISH	KUR	KURDISH	SWE	SWEDISH
DUT	DUTCH	LAV	LATVIAN	TIB	TIBETAN
ENG	ENGLISH	LIT	LITHUANIAN	TUR	TURKISH
EST	ESTONIAN	MAC	MACEDONIAN	UKR	UKRAINIAN
FIN	FINNISH	MLT	MALTESE		
FRA	FRENCH	NOR	NORWEGIAN		

Table 4: Available language names and abbreviations.

6.4 Using the Interpreter Station



Important:

- Before powering the system up, set the MICROPHONE switch on each Interpreter Station to "OFF" to avoid "broadcasting" any unofficial conversations.

Upon system power-up,

- The display shows the message "SYSTEM STARTING..." until synchronization is completed. Once synchronization is finished, the display shows the main menu.
- The microphone input is automatically routed to output A and the red LED above OUTPUT SELECT key <A> is lit. The microphone will be open only if the MICROPHONE switch is in its center position ("ON"). When the microphone is open, the red LED on the microphone arm will be lit.

Section 6: CS5 IU Interpreter Station

- If the MICROPHONE switches on both Interpreter Stations are in their "ON" positions, the microphone on the Interpreter Station with the lower (odd) address will be opened. The microphone on the Interpreter Station with the higher (even) address will be muted. On the active Interpreter Station, the red LED above the active OUTPUT SELCT key and the red LED on the microphone arm will be lit, while corresponding LED's on the other Interpreter Station will remain dark.

6.5 Instruct the interpreters how to use the Interpreter Stations:

1. Select your source language:
 - If the person using the floor microphone speaks your source language, press <FLOOR>. You will hear the floor talker on your headphones and the display shows the message "FLOOR".
 - If you need your colleagues' relay, press <RELAY>. On your headphones, you will hear the voice of the interpreter working into the relay language. The display shows the message "RELAY". The microphone signal will be automatically routed to output A.
 - To select one of the other available source languages, press <INPUT/A> or <INPUT/B>. You will hear the selected language on your headphones and the display indicates the selected language".
2. Use the VOLUME, BASS, and TREBLE controls to adjust the headphone volume and sound for optimum intelligibility. These controls also set the volume and sound of the loudspeaker on the Interpreter Station.
3. Select your target language:
 - To interpret from the floor language (e.g., English) into your booth's target language (e.g., Portuguese), check that output A is selected (the red LED above the OUTPUT SELECT <A> key is lit). If it is not, press <A>.
 - If a speaker of your booth's target language (e.g., Portuguese) takes the floor and you are required to interpret into the relay language (e.g., English), press to select output B. The red LED above the OUTPUT SELECT key is lit and the headphones are automatically switched to the floor channel. (Tech note: The floor channel is automatically fed to the language channel selected for output A to save delegates the trouble of having to switch their headphones to the floor channel.)



Note:

Pressing an OUTPUT SELECT key on one control panel will route the other control panel (which becomes a "slave" to the first panel) in the booth to the same output channel. The appropriate LED on the "slave" control panel will be lit accordingly.

Section 6: CS5 IU Interpreter Station

4. Controlling the microphones:

- The interpreter who agreed to begin opens their microphone by setting the MICROPHONE switch to "ON" and the other interpreter switches their microphone OFF (unless it is off already). The red LED on the open microphone and the red LED above the active OUTPUT SELECT key are lit.

**Important:**

Make sure never to switch both microphones in your booth ON simultaneously. If you do, only one microphone will be activated and the other muted automatically, so the wrong microphone may come on.

- When it is time to relieve your colleague, you can do so in one of two ways:
 - Method 1: The interpreter on duty switches their microphone OFF (the red LED on the microphone goes out) and the other interpreter switches their microphone ON (the red LED on the microphone comes on).

- Method 2: The interpreter taking over presses the appropriate OUTPUT SELECT key. The red LED on the microphone comes on, the relieved colleague's microphone is automatically muted, and the red LED on that microphone goes dark.

Note that when using this method, one microphone will always be open. To make sure your listeners will not hear any of your internal conversations; always set the MICROPHONE switches on both control panels to OFF when none of you is interpreting.

5. Controlling talkers:

- If the person delivering a speech talks too fast, press <CALL> momentarily. This causes the green LED on the microphone arm on the talker's Delegate Unit to flash for five seconds. The display on your control panel shows the message "SENDING SLOWLY PLEASE". To stop the signal before the five seconds are over, press <CALL> again.

6. Calling a technician (if the system is computer controlled and a technician is available):

- If there is a technical problem or you have run out of water, etc. hold down <CALL> for at least three seconds. This causes an appropriate message to appear on the computer monitor and the message "CALLING TECHNICIAN" to appear on your control panel display. To delete the messages, press and hold <CALL> again for at least three seconds.

Section 7: Infrared Transmission System

7.1 CS5 IRT 1 and CS5 IRT 2 Infrared Radiators

7.1.1 General

The CS5 IRT 1 and CS5 IRT 2 infrared radiators are capable of transmitting seven interpretation channels to the CS5 IRR 7 infrared receivers. The two radiator models are technically identical, except that the CS5 IRT 2 is larger than and provides about twice the radiation range of the CS5 IRT 1.

Each infrared radiator comes complete with a mounting bracket for installation on a wall or ceiling.

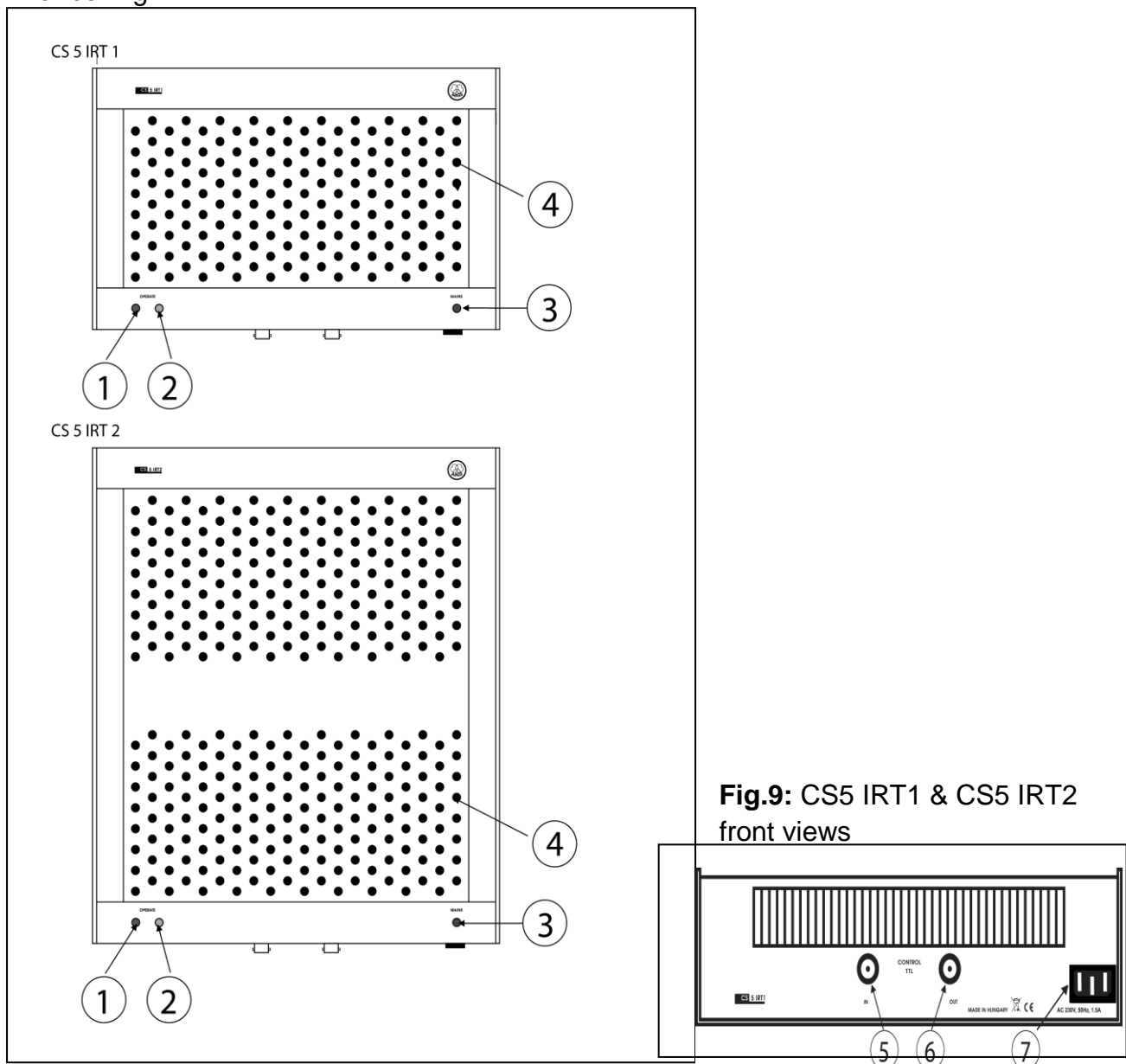

Fig.9: CS5 IRT1 & CS5 IRT2 front views

Fig. 9a: CS5 IRT 1/CS5 IRT 2 bottom panel.

Section 7: Infrared Transmission System

Refer to
Fig. 9a
above

1. **Green OPERATE LED:** The green OPERATE LED is lit to indicate that signal is being radiated.
2. **Yellow OPERATE LED:** The yellow OPERATE LED is lit to indicate that the infrared driver circuitry is in standby mode.
3. **MAINS:** This red LED is lit to indicate that power to the radiator is ON.
4. **IREDS**
5. **IN:** BNC input connector for the PPM modulated time-multiplexed signal driving the IREDS (infrared emitting diodes) (7).
6. **OUT:** This BNC output connector is connected in parallel to the IN connector allowing you to daisy-chain several infrared radiators.
7. **Power input:** Standard IEC power connector for 230 V/50 Hz.

7.1.2 Placement

- Basically, it is best to place the infrared radiators as close as possible to the area where the receivers will be used and as high above the floor as practical. Diagram 1 in the Quickstart Manual shows an example of two infrared radiators covering the delegates' tables only.
- To cover an entire room, place one infrared radiator in each corner of the conference room, at least 10 feet (3 m) above the floor, aligning the front panel to face the opposite corner.
Walls and/or ceilings that are painted a dark color, paneled, or acoustically treated will absorb more infrared radiation than white surfaces, so you will need more infrared radiators in darker rooms.
- Sunlight, fluorescent lighting, and photo flashes may weaken infrared radiation. Therefore, try to place the infrared radiators where they will not be exposed to natural or artificial light or use some extra IRTs.

**Note:**

Working out the exact number of infrared radiators needed for optimum room coverage and placing them correctly can be a challenge in some rooms. As a rule of thumb, it is better to use many small (CS5 IRT 1) radiators than only a few large ones (CS5 IRT 2). If you need assistance, your dealer or nearest AKG Distributor will be glad to help.

7.1.3 Mounting

- For mobile use, you can fix the support frame of the infrared radiator on a heavy standard loudspeaker stand.

Section 7: Infrared Transmission System

- For permanent installations, you can directly screw the support frame on a wall or ceiling at any desired angle. To mount a radiator in a corner, you may need additional angle brackets (available from hardware stores).
- To set the tilt angle of the radiator, slacken the set screws on the support frame, rotate the radiator to the desired angle, and tighten the set screws.

7.1.4 Connections

**Important:**

To avoid damage to any system components, do not lay, connect, or disconnect any cables while power to the system is on. Always disconnect the entire system from power before making any changes to the wiring.

1. Use RG58 50-ohm coaxial cable and BNC connectors to connect one INFRA OUT jack on the Base Unit rear panel to the IN BNC jack on the infrared radiator on the left side of the room.
2. Use a cable of the same length (or as nearly as possible) to connect the other INFRA OUT jack on the Base Unit rear panel to the IN BNC jack on the infrared radiator on the right side of the room.
3. If you need to use more than one radiator on either bus, use RG58 50-ohm coaxial cable and BNC connectors to connect the OUT jack on the first radiator to the IN jack on the subsequent radiator, and so on.

**Note:**

To ensure consistent performance of the two radiators, keep the difference in length between the two cables to a practical minimum (less than 164 feet/50 m).

4. Connect each infrared radiator to power.
The CS5 IRT 1 and CS5 IRT 2 infrared radiators have no power switches. Therefore, connect the power input on each radiator to a switched 230 V/50 Hz power outlet protected by an appropriate fuse.

**Important:**

- If no switched power outlets are available at the site of a permanent installation, ask a qualified electrician to install the required number of outlets in the conference room and a suitable ON/OFF switch in the control room in accordance with local electrical and occupational safety regulations.

Section 7: Infrared Transmission System

7.2 CS5 IRR 7 Infrared Receiver

7.2.1 General

The CS5 IRR 7 is a light, portable infrared receiver for use with the CS5 IRT 1 and CS5 IRT 2 infrared radiators. It provides seven selectable audio channels, a mini-jack headphone output, volume control, and ON key. The receiver is powered by a standard 6F22 9 V rechargeable battery lasting for up to 13 hours per charge. Charging contacts on the receiver body enable the battery inside the receiver to be charged on the CS5 CU 50 charger with no need to remove the battery.

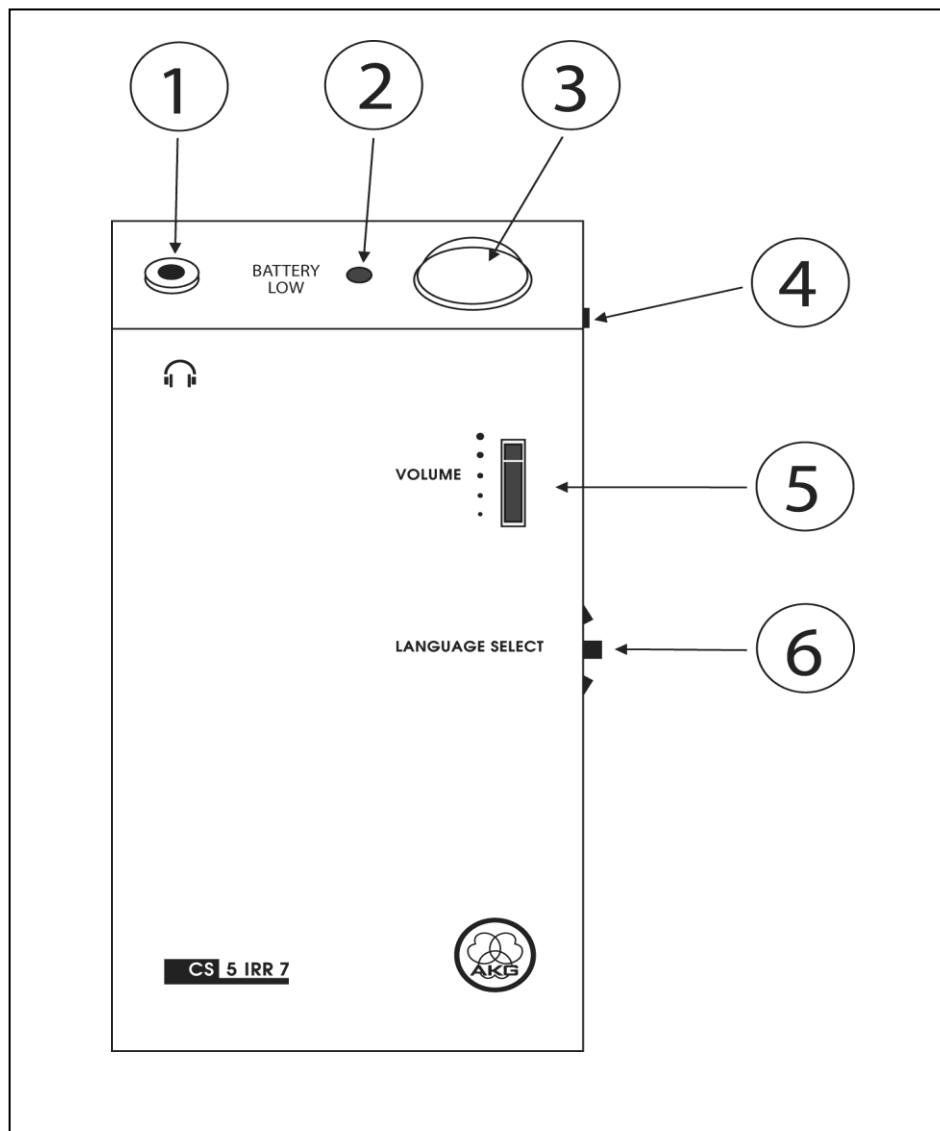



Fig. 10: Front and top panels of the CS5 IRR 7 infrared receiver.

Section 7: Infrared Transmission System

1.  : TRS mini jack for connecting a pair of stereo headphones.
2. **ON**: This key on the side of the receiver switches power to the receiver ON. The receiver will switch OFF automatically about 30 seconds after the infrared signal has stopped.
3. **BATTERY**: This bi-color LED indicates the current battery status in operating and charging modes.
 - In operating mode, the LED indicates the current battery capacity and warns you that the battery needs charging when battery capacity is low.
 - In charging mode, the LED is lit to indicate the battery is being charged and starts flashing when the battery is charged to capacity.
4. **Plastic collecting lens** for the infrared receiving diode.
5. **VOLUME**: This rotary control sets the volume of the headphones connected to the receiver.
6. **LANGUAGE SELECT**: This rotary switch on the side of the receiver selects one of seven language channels. The actual number of languages available depends on the number of languages into which interpretation is provided.

7.2.2 Using the Infrared Receiver

Refer to
Fig.10 on
page 61

1. Connect the headphones to the jack (1). **Make sure to turn the VOLUME control (5) to its minimum position to avoid damaging your hearing by excessive sound levels.**
2. To switch power to the receiver on, press the <ON> key (2) on the receiver side panel. The BATTERY LED (3) provides the following information:

LED...	Status	Required action
...is lit green for 2 seconds after pressing <ON> , then flashes green .	Battery is adequately charged for normal operation.	None.
...starts flashing red .	Battery will be dead in about 15 minutes.	<ul style="list-style-type: none"> • Charge battery as soon as possible.
...remains dark after pressing <ON>.	<ul style="list-style-type: none"> • Battery is completely discharged. • There is no battery inside the receiver 	<ul style="list-style-type: none"> • Charge battery as soon as possible. • Contact your nearest AKG Service Center or Distributor.

3. Use the LANGUAGE SELECT rotary switch (6) to select the desired language from the list of interpreted languages provided by the organizers (or by ear, if no such list is available).
4. Use the VOLUME control (5) to set the volume level of your headphones just loud enough so you can hear clearly what is being said.

Section 7: Infrared Transmission System



Important:

- Do not turn the headphones volume up any higher than necessary. Listening to excessive sound levels on headphones may damage your hearing.
- (Refer to fig. 10 on page 37.) Never cover the collecting lens (4) above the infrared receiving diode. Covering the lens (4) will cut the signal and may cause the receiver to switch off automatically.



Note: The signal may fade in some spots within the conference room due to interference or shadow effects. If that happens, move away from such a spot.

5. If the BATTERY LED (3) on the receiver top panel starts flashing, the battery will be dead soon. Return the receiver to conference staff. They will give you a receiver with a fully charged battery.
6. You cannot switch power to the receiver off. The receiver will switch off automatically 30 seconds after the infrared signal has stopped.



Note:

The receiver will also switch off automatically before the battery is completely discharged to avoid damaging the battery.

7.2.3 Replacing Batteries

The infrared receiver is delivered with a 280 mAh 9 V NiMH rechargeable batteries installed.



Important:

- The battery cannot be replaced by the user. When the battery needs replacing, contact your nearest AKG Service Center or AKG Distributor.

Section 7: Infrared Transmission System

7.3 CS5 CU 50 Charger/Storage Case

7.3.1 General

The CS5 CU 50 is a combined charger and transport/storage unit in a rugged, lockable flight case. It allows you to store up to 50 CS5 IRR 7 infrared receivers during a conference and charges the batteries inside them. Each charging slot has its own independent charging control circuit.

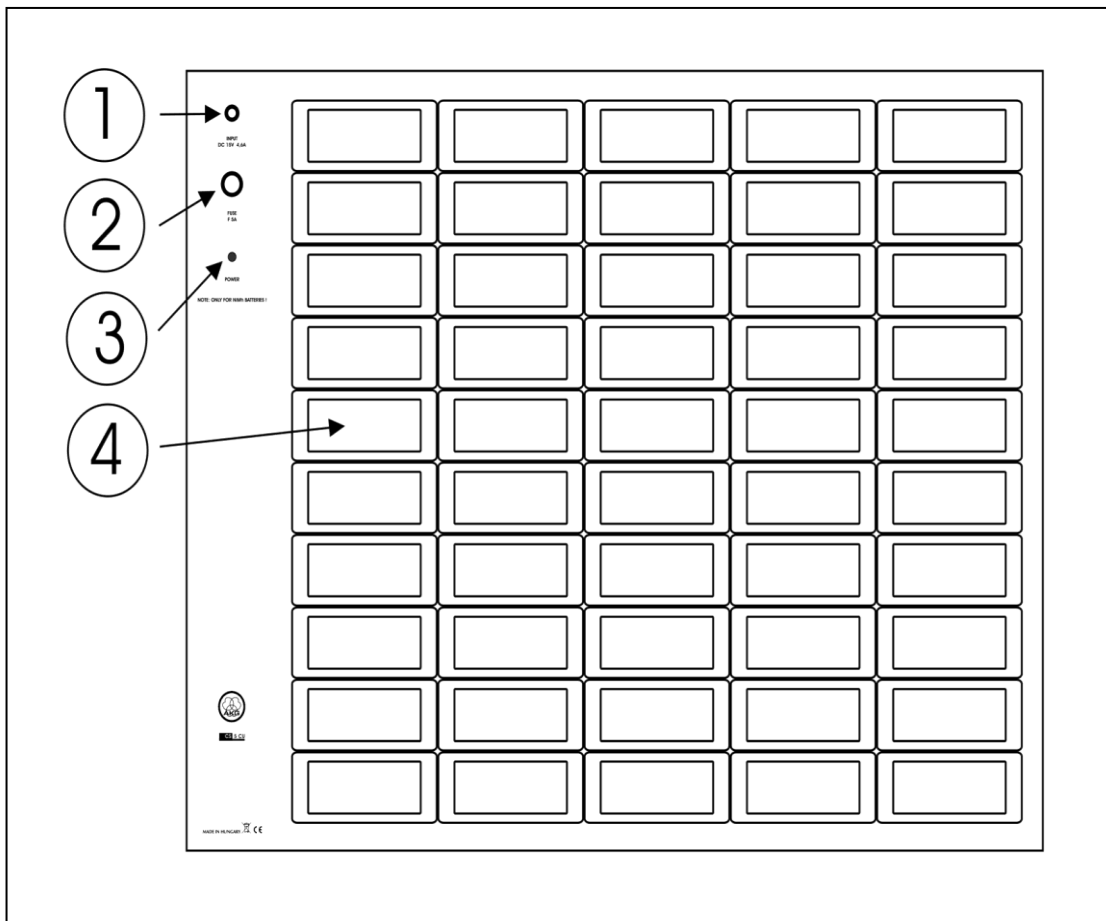

Fig. 11: CS5 CU 50 control panel and charging slots.

1. **DC 15V 4.6A:** Input connector for the DC cable of the supplied dedicated power supply. The power supply operates on any voltage from 100 to 240 VAC.
2. **FUSE:** 5 A, fast-blow fuse.
3. **POWER:** This red LED is lit to indicate that power to the charger is ON.
4. **Charging slot** for charging the battery inside a receiver. The charger provides 50 charging slots.

Section 7: Infrared Transmission System

7.3.2 Charging Batteries

Refer to
Fig. 11 on
page 64

1. Unlock and remove the lid from the flight case.
2. Connect the DC cable on the supplied AC adapter to the DC 15V 4.6A jack on the CS5 CU 50 charger.
3. Connect the AC adapter to a convenient power outlet.



Important:

- To avoid any risk of damage, do not use any power supply other than the AC adapter included with the charger.
- To avoid any risk of damage, fire, or explosion, never insert a receiver with dry (non-rechargeable) batteries inside into any charging slot.

4. Insert each receiver whose battery needs charging (BATTERY LED flashing) into a charging slot (4) with the charging contacts facing the bottom of the charging slot. Charging will start automatically and the BATTERY LED on the receiver will be lit red constantly. As soon as the battery is charged to capacity, the BATTERY LED on the receiver will start flashing red to indicate the battery is being trickle-charged.
5. Remove the receiver from the charging slot.



Note:

Charging time depends on battery capacity. It is approximately four hours for a 280 mAh 9 V NiMH rechargeable batteries.

7.3.3 Battery Care

1. Always store the batteries inside the receivers in charged condition. Storing rechargeable batteries uncharged would significantly reduce their useful life.
2. If you do not use a receiver for a long period of time, charge its battery to capacity every one or two months, no matter to what level the battery has been charged before. This is important because the battery will self-discharge even when the receiver is switched off.
3. Do not store receivers in trickle-charging mode in the CU 50 indefinitely. This may reduce the useful life of the battery inside the receiver. After a conference has ended, charge all receivers to capacity and switch power to the CU 50 off.

Section 8: System Components

Base Station

CS5 BU	Base Unit for up to 5,000 microphone stations, including PC Software, SERVICE CARD, printed Quick Start Manual, CD based User Manual
CS5 PS12	Power supply for Base Unit and up to six microphone stations
CS MKAC EU	European standard power cable
CS MKAC US	US standard power cable
CS MKAC UK	UK standard Power cable

Microphone Stations

CS5 DU	Basic Delegate Station
CS5 VU	Voting/Chairperson Station
CS5 ID10	Set of 10 ID Cards
CS5 IU	Interpreter Station

Goosenecks

GN30 CS	Screw-on Gooseneck, approx. 30 cm
GN50 CS	Screw-on Gooseneck, approx. 50 cm

Microphone Capsules

CK31	Cardioid microphone capsule
CK32	Omni directional microphone capsule
CK33	Hypercardioid microphone capsule
CK47	Shotgun microphone capsule
CK80	Shotgun microphone capsule

Cables

CS5 MK1,25	1.25-m LAN cable
CS5 MK2,5	2.5-m LAN cable
CS5 MK5	5-m LAN cable
CS5 MK10	10-m LAN cable
CS5 MK20	20-m LAN cable

Infrared Transmission System

CS5 IRT1	Small infrared radiator
CS5 IRT2	Large infrared radiator
CS5 IRR7	Infrared receiver with stereo mini jack
CS5 CU50	Charging and storage case for up to 50 CS5 IRR7 receivers

Section 9: Specifications

9.1 CS5 BU

9.1.1 General

	Minimum	Nominal	Maximum	Unit
DC 48V / 3A IN				
Input voltage	46	48	50	VDC
Power requirement	3	-	4	W
LINE IN (balanced)				
Input level	-	0	+6	dBu
Impedance	-	20	-	kohms
TELEPHONE IN (balanced)				
Input level	-	0	+6	dBu
Impedance	-	20	-	kohms
EFFECT IN (balanced)				
Input level	-	0	+6	dBu
Impedance	-	20	-	kohms
TAPE IN (unbalanced, stereo*)				
Input level	-	-10	-4	dBu
Impedance	-	20	-	kohms
EXT. LANG IN (balanced)				
Input level	-	0	+6	dBu
Impedance	-	20	-	kohms
EXT. MIC. IN				
Input level	-	-40	-34	dBu
Impedance	-	20	-	kohms
Phantom power	-	48	-	V
Output Levels				
LINE OUT (balanced)	-	0	+6	dBu
TELEPHONE OUT (balanced)	-	0	+6	dBu
EFFECT OUT (balanced)	-	0	+6	dBu
TAPE OUT (unbal., stereo*)	-	-10	-4	dBu
Output Load	-	1	-	kohm
Output Frequency Range (-3dB)	20	-	20k	Hz
Headphone Output				
Power	-	90	200	mW
Load impedance	8	32	-	ohms
Frequency range (-3dB)	45	-	22k	Hz
Physical Dimensions				
Height		1/1.75/44		U/in./mm
Width		18/482		in./mm
Depth inc. connector protrusion		4.25/108		in./mm
Weight		3.2/1450		lbs./g

* Use TRS plugs only. Connecting a TS plug would short the ring contact to ground and damage the device.

Section 9: Specifications

9.1.2 Connector Pin outs

DC 48V / 3A IN DC power jack	
Pin no.	Function
1	Supply voltage
2	GND

LINE IN, TEL. IN, EXT. LANG. IN, EXT. MIC. IN 3-pin female XLR	
Pin no.	Function
1	GND
2	Audio -
3	Audio +

LINE OUT, TEL. OUT 3-pin female XLR	
Pin no.	Function
1	GND
2	Audio -
3	Audio +

EFFECT IN, EFFECT OUT 1/4" TRS jacks	
Pin no.	Function
Tip	Audio inphase
Ring	Audio
Sleeve	Ground

TAPE IN, TAPE OUT TRS mini jacks	
Pin no.	Function
Tip	Audio inphase
Ring	Audio
Sleeve	Ground

HEADPHONE 1/4" TRS jack	
Pin no.	Function
Tip	Right
Ring	Left
Sleeve	Ground

Section 9: Specifications

SYSTEM 8-pin RJ45	
Pin no.	Function
1	Data send +
2	Data send -
3	Data receive +
4	48 VDC
5	48 VDC
6	Data receive -
7	Ground
8	Ground

INFRA OUT BNC	
Pin no.	Function
1	PPM data signal
2	Ground

USB Port USB-B	
Pin no.	Function
1	+5 V
2	USB data +
3	USB data -
4	Ground

Section 9: Specifications

9.2 CS5 DU/VU

9.2.1 General

	Minimum	Nominal	Maximum	Unit
Power Supply				
Supply voltage	46	48	50	V
Power consumption	-	1.5	3	W
Headphone Output				
Power	-	30	60	mW
Load impedance	8	32	-	ohms
Frequency range (-3 dB)	45	-	22k	Hz
Physical Dimensions				
Signal/noise ratio	70	-	-	dB
Width		10.1/257		in./mm
Depth		5.8/147		in./mm
Height		1.9/73		in./mm

9.2.2 Connector Pin outs

HEADPHONE 1/4" TRS jack*	
Pin no.	Function
Tip	Right
Ring	Left
Sleeve	Ground

* Use stereo headphones with TRS plugs only. Connecting a TS plug would short the ring contact to ground and damage the device.

SYSTEM 8-pin RJ45	
Pin no.	Function
1	Data send +
2	Data send -
3	Data receive +
4	48 VDC
5	48 VDC
6	Data receive -
7	Ground
8	Ground

Section 9: Specifications

9.3 CS5 IU

9.3.1 General

	Minimum	Nominal	Maximum	Unit
Power Supply				
Supply voltage	46	48	50	V
Power consumption	-	1.5	3	W
Microphone Input				
Frequency range (-3 dB)	100	-	16k	Hz
Signal/noise ratio (digital signal measured with short-circuited input)	60	-	-	dB
Headphone Output				
Power	-	180	250	mW
Load impedance	8	32	-	ohms
Physical Dimensions				
Width		12.2/310		in./mm
Depth		6.0/152		in./mm
Height		3.4/86		in./mm
Weight		2.2/1000		lbs./g

9.3.2 Connector Pin outs

Headphone Output 1/4" TRS jack	
Pin no.	Function
Tip	Right
Ring	Left
Sleeve	Ground

External Microphone 1/4" TRS jack	
Pin no.	Function
Tip	Audio (hot)
Ring	Audio
Sleeve	Ground

Section 9: Specifications

SYSTEM 8-pin RJ45	
Pin no.	Function
1	Data send +
2	Data send -
3	Data receive +
4	48 VDC
5	48 VDC
6	Data receive -
7	Ground
8	Ground

9.4 CS5 PS 12

General	
Efficiency	85% typical at 230 VAC & 100% load
Input	
Input voltage	90-264 VAC
Input frequency	47-63 Hz
Input current	1.85 A max
Power factor	Compliant with EN61000-3-2
Output	
Output voltage	48 V
Output power	72 W
Short circuit protection	Continuous
Environmental	
Operating temperature	0°C to +65°C
Storage temperature	-20 °C to +85 °C
Safety	
Safety approvals	EN60950-1, UL60950-1, CAN/CSA C22.2 No. 60950
Dimensions	
Width x depth x height	2.29 (58.0) x 5.20 (132.0) x 1.18 (30.0) in. (mm)
Weight	0.77 (350) lbs. (g)

Section 9: Specifications

9.5 CS5 IRT 1 and CS5 IRT 2

	CS5 IRT 1	CS5 IRT 2
IN	0-5 V / 50 ohms	0-5 V / 50 ohms
OUT	0-5 V / 50 ohms	0-5 V / 50 ohms
Power voltage	200-240V 50/60Hz, 1.5A or 100-120V 50/60Hz, 3.15A (internally selectable)	200-240V 50/60Hz, 1.5A or 100-120V 50/60Hz, 3.15A (internally selectable)
Wavelength	870 nm	870 nm
Radiated power	2.5 W	3.8 W
Coverage angle (50% down)	±22 degrees	±22 degrees
Coverage area	6,450 sq.ft. / 600 m ²	10,750 sq.ft. / 1000 m ²
Width	10.3 in. / 264 mm	10.3 in. / 264 mm
Height	6.3 in. / 160 mm	12.1 in. / 307 mm
Depth	3.0 in. / 77 mm	3.0 in. / 77 mm
Weight	5.6 lbs. / 2.5 kg	8.9 lbs. / 4 kg

9.6 CS5 IRR 7

General	
Number of channels	7
Receiving angle	140 degrees
Power supply	280 mAh, 9 V NiMH rechargeable battery
Battery life	13 hours min
Headphone Output	
Rated output power into 32 ohms	9 mW
Load impedance	32 ohms min
Physical Dimensions	
Height	5.3 in. / 136 mm
Width	2.7 in. / 70 mm
Depth	1.1 in. / 28 mm
Weight	4.9 oz. / 140 g

Section 9: Specifications

9.7 CS5 CU 50

General	
Number of charging/storage slots	50
Charging modes	Quick or trickle charging, automatically selected
Power supply	230 VAC, 15 VDC, 4.6 A
Quick Charging Mode	
Charging current	80 mA, continuous
Trickle Charging Mode	
Charging current	4 mA (avg.), pulsed
Physical Dimensions	
Height	7.5 in. / 190 mm
Width	23 in. / 585 mm
Depth	19 in. / 483 mm
Weight	3.1 lbs. / 14 kg

9.8 Conformity

This product conforms to the standards listed in the related Declaration of Conformity. To order a free copy of the declaration of Conformity for this product, visit <http://www.akg.com> or contact sales@akg.com.

Mikrofone · Kopfhörer · Drahtlosmikrofone · Drahtloskopfhörer · Kopfsprechgarnituren · Akustische
Komponenten Microphones · Headphones · Wireless Microphones · Wireless Headphones · Headsets ·
Electroacoustical Components Microphones · Casques HiFi · Microphones sans fil · Casques sans fil ·
Micros-casques · Composants acoustiques Microfoni · Cuffie HiFi · Microfoni senza filo · Cuffie senza filo ·
Cuffie-microfono · Componenti acustici

Micrófonos · Auriculares · Micrófonos inalámbricos · Auriculares inalámbricos · Auriculares con micrófono · Componentes
acústicos

Microfones · Fones de ouvido · Microfones s/fios · Fones de ouvido s/fios · Microfones de cabeça ·
Componentes acústicos

AKG Acoustics GmbH

Lemböckgasse 21–25, A-1230 Vienna/AUSTRIA, phone: (+43-1) 86654-0*
e-mail: sales@akg.com

For other products and distributors worldwide visit www.akg.com



Technische Änderungen vorbehalten. Specifications subject to change without notice. Ces caractéristiques sont susceptibles de
modifications. Ci riserviamo il diritto di effettuare modifiche tecniche. Nos reservamos el derecho de introducir modificaciones
técnicas. Especificações sujeitas a mudanças sem aviso prévio

9100 U 13150